

**FLUKE®**

**Biomedical**

# **medTester 5000C**

## **Biomedical Tester**

# **Operators Manual**

PN 2243153

February 2006

© 2006 Fluke Corporation, All rights reserved. Printed in USA  
All product names are trademarks of their respective companies.

## ***Warranty and Product Support***

Fluke Biomedical warrants this instrument against defects in materials and workmanship for one full year from the date of original purchase. During the warranty period, we will repair or, at our option, replace at no charge a product that proves to be defective, provided you return the product, shipping prepaid, to Fluke Biomedical. This warranty does not apply if the product has been damaged by accident or misuse or as the result of service or modification by other than Fluke Biomedical. IN NO EVENT SHALL FLUKE BIOMEDICAL BE LIABLE FOR CONSEQUENTIAL DAMAGES.

Only serialized products and their accessory items (those products and items bearing a distinct serial number tag) are covered under this one-year warranty. PHYSICAL DAMAGE CAUSED BY MISUSE OR PHYSICAL ABUSE IS NOT COVERED UNDER THE WARRANTY. Items such as cables and nonserialized modules are not covered under this warranty.

Recalibration of instruments is not covered under the warranty.

This warranty gives you specific legal rights, and you may also have other rights which vary from state to state, province to province, or country to country. This warranty is limited to repairing the instrument to Fluke Biomedical's specifications.

### ***Warranty Disclaimer***

Should you elect to have your instrument serviced and/or calibrated by someone other than Fluke Biomedical, please be advised that the original warranty covering your product becomes void when the tamper-resistant Quality Seal is removed or broken without proper factory authorization. We strongly recommend, therefore, that you send your instrument to Fluke Biomedical for factory service and calibration, especially during the original warranty period.

## Notices

---

### All Rights Reserved

© Copyright 2006, Fluke Biomedical. No part of this publication may be reproduced, transmitted, transcribed, stored in a retrieval system, or translated into any language without the written permission of Fluke Biomedical.

---

### Copyright Release

Fluke Biomedical agrees to a limited copyright release that allows you to reproduce manuals and other printed materials for use in service training programs and other technical publications. If you would like other reproductions or distributions, submit a written request to Fluke Biomedical.

---

### Unpacking and Inspection

Follow standard receiving practices upon receipt of the instrument. Check the shipping carton for damage. If damage is found, stop unpacking the instrument. Notify the carrier and ask for an agent to be present while the instrument is unpacked. There are no special unpacking instructions, but be careful not to damage the instrument when unpacking it. Inspect the instrument for physical damage such as bent or broken parts, dents, or scratches.

---

### Technical Support

For application support or answers to technical questions, either email [techservices@flukebiomedical.com](mailto:techservices@flukebiomedical.com) or call 1-800- 648-7952 or 1-425-446-6945.

---

### Claims

Our routine method of shipment is via common carrier, FOB origin. Upon delivery, if physical damage is found, retain all packing materials in their original condition and contact the carrier immediately to file a claim. If the instrument is delivered in good physical condition but does not operate within specifications, or if there are any other problems not caused by shipping damage, please contact Fluke Biomedical or your local sales representative.

---

### Standard Terms and Conditions

#### **Refunds and Credits**

Please note that only serialized products and their accessory items (i.e., products and items bearing a distinct serial number tag) are eligible for partial refund and/or credit. Nonserialized parts and accessory items (e.g., cables, carrying cases, auxiliary modules, etc.) are not eligible for return or refund. Only products returned within 90 days from the date of original purchase are eligible for refund/credit. In order to receive a partial refund/credit of a product purchase price on a serialized product, the product must not have been damaged by the customer or by the carrier chosen by the customer to return the goods, and the product must be returned complete (meaning with all manuals, cables, accessories, etc.) and in “as new” and resalable condition. Products not returned within 90 days of purchase, or products which are not in “as new” and resalable condition, are not eligible for credit return and will be returned to the customer. The Return Procedure (see below) must be followed to assure prompt refund/credit.

**Restocking Charges**

Products returned within 30 days of original purchase are subject to a minimum restocking fee of 15 %. Products returned in excess of 30 days after purchase, but prior to 90 days, are subject to a minimum restocking fee of 20 %. Additional charges for damage and/or missing parts and accessories will be applied to all returns.

**Return Procedure**

All items being returned (including all warranty-claim shipments) must be sent freight-prepaid to our factory location. When you return an instrument to Fluke Biomedical, we recommend using United Parcel Service, Federal Express, or Air Parcel Post. We also recommend that you insure your shipment for its actual replacement cost. Fluke Biomedical will not be responsible for lost shipments or instruments that are received in damaged condition due to improper packaging or handling.

Use the original carton and packaging material for shipment. If they are not available, we recommend the following guide for repackaging:

- Use a double-walled carton of sufficient strength for the weight being shipped.
- Use heavy paper or cardboard to protect all instrument surfaces. Use nonabrasive material around all projecting parts.
- Use at least four inches of tightly packed, industry-approved, shock-absorbent material around the instrument.

**Returns for partial refund/credit:**

Every product returned for refund/credit must be accompanied by a Return Material Authorization (RMA) number, obtained from our Order Entry Group at 1-800-648-7952 or 1-425-446-6945.

**Repair and calibration:**

To find the nearest service center, goto [www.flukebiomedical.com/service](http://www.flukebiomedical.com/service) or

In the U.S.A.:

Cleveland Calibration Lab  
Tel: 1-800-850-4606  
Email: [globalcal@flukebiomedical.com](mailto:globalcal@flukebiomedical.com)

Everett Calibration Lab  
Tel: 1-888-99 FLUKE (1-888-993-5853)  
Email: [service.status@fluke.com](mailto:service.status@fluke.com)

In Europe, Middle East, and Africa:

Eindhoven Calibration Lab  
Tel: +31-402-675300  
Email: [ServiceDesk@fluke.com](mailto:ServiceDesk@fluke.com)

In Asia:

Everett Calibration Lab  
Tel: +425-446-6945  
Email: [service.international@fluke.com](mailto:service.international@fluke.com)

---

**Certification**

This instrument was thoroughly tested and inspected. It was found to meet Fluke Biomedical's manufacturing specifications when it was shipped from the factory. Calibration measurements are

traceable to the National Institute of Standards and Technology (NIST). Devices for which there are no NIST calibration standards are measured against in-house performance standards using accepted test procedures.

---

## **WARNING**

Unauthorized user modifications or application beyond the published specifications may result in electrical shock hazards or improper operation. Fluke Biomedical will not be responsible for any injuries sustained due to unauthorized equipment modifications.

---

## **Restrictions and Liabilities**

Information in this document is subject to change and does not represent a commitment by Fluke Biomedical. Changes made to the information in this document will be incorporated in new editions of the publication. No responsibility is assumed by Fluke Biomedical for the use or reliability of software or equipment that is not supplied by Fluke Biomedical, or by its affiliated dealers.

---

## **Manufacturing Location**

The medTester 5000C is manufactured in Everett, WA, U.S.A.



## Table of Contents

### 1 : G E N E R A L I N F O R M A T I O N

<b>SAFETY CONSIDERATIONS</b> .....	1-1
General.....	1-1
Safety Symbols .....	1-1
<b>Introduction</b> .....	1-2
<b>How to Use This Manual</b> .....	1-3
<b>If You've Used The medTester 5000C Before...</b> .....	1-3
<b>If You're New to The medTester 5000C...</b> .....	1-3
<b>Where to Find Help</b> .....	1-4
<b>Features</b> .....	1-5
<b>Electrical Safety Testing</b> .....	1-5
<b>Performance Testing</b> .....	1-5
<b>Manual Measurements</b> .....	1-5
<b>Automatic Measurements</b> .....	1-5
<b>Computer Control</b> .....	1-6
<b>medCheck</b> .....	1-6
<b>medTester 5000C Optional Modules</b> .....	1-7
<b>Features</b> .....	1-11
<b>Optional Accessories</b> .....	1-11
<b>medTester 5000C Instrument Specifications</b> .....	1-12
<b>Line Voltage and Measurements</b> .....	1-12
<b>Leakage Current</b> .....	1-12
<b>Equipment Current</b> .....	1-13
<b>Resistance</b> .....	1-13
<b>Isolated Power</b> .....	1-13
<b>Toolbox</b> .....	1-14
<b>Test Receptacle</b> .....	1-14
<b>Ground Fault Circuit Interrupter</b> .....	1-15
<b>Performance Waveforms</b> .....	1-15
<b>General Specifications</b> .....	1-16
<b>ECG Connections</b> .....	1-16
<b>Data Input and Output</b> .....	1-16
<b>RS-232C Serial Interface Parameters</b> .....	1-16
<b>Real Time Clock</b> .....	1-16
<b>Accessories</b> .....	1-17
<b>medTester 5000C Module Upgrades</b> .....	1-19
<b>2 : I N S T A L L A T I O N</b>	
<b>Factory Default Settings</b> .....	2-1
<b>Power-Up Sequence</b> .....	2-2
<b>Initialization</b> .....	2-3

<b>Date and Time Setup .....</b>	<b>2-3</b>
<b>Audio Transducer.....</b>	<b>2-4</b>
<b>Enabling Modules .....</b>	<b>2-5</b>
<b>Confirming Module Installation.....</b>	<b>2-7</b>
<b>3 : I N S T R U M E N T F A M I L I A R I T Y</b>	
<b>Know Your medTester 5000C .....</b>	<b>3-1</b>
<b>Top Panel Controls, Displays, and Connectors.....</b>	<b>3-1</b>
<b>Rear Panel Controls, Displays, and Connectors .....</b>	<b>3-3</b>
<b>Power Up .....</b>	<b>3-4</b>
<b>Navigating the Menus .....</b>	<b>3-4</b>
<b>4 : M A N U A L T E S T S</b>	
<b>Performing Manual Tests.....</b>	<b>4-35</b>
<b>Printing Manual Measurements .....</b>	<b>4-35</b>
<b>Line Voltage .....</b>	<b>4-35</b>
<b>Leakage Current.....</b>	<b>4-36</b>
<b>ECG Lead Leakage .....</b>	<b>4-38</b>
<b>Equipment Current .....</b>	<b>4-42</b>
<b>Resistance.....</b>	<b>4-42</b>
<b>Isolated Power and Ground Fault Test .....</b>	<b>4-44</b>
<b>Toolbox.....</b>	<b>4-45</b>
<b>5 : A U T O S E Q U E N C E S</b>	
<b>What Is an Autosequence .....</b>	<b>5-1</b>
<b>Description of Standard Safety Autosequences .....</b>	<b>5-2</b>
<b>Autosequence Selection .....</b>	<b>5-3</b>
<b>Standard Safety Autosequence Names .....</b>	<b>5-4</b>
<b>Autosequence Device Prompts .....</b>	<b>5-5</b>
<b>Autosequence Steps .....</b>	<b>5-7</b>
<b>System Line Voltage .....</b>	<b>5-8</b>
<b>Power Cord Resistance.....</b>	<b>5-8</b>
<b>Leakage Current Measurements.....</b>	<b>5-9</b>
<b>Equipment Current Measurement .....</b>	<b>5-9</b>
<b>ECG Performance Waveforms .....</b>	<b>5-10</b>
<b>End-of-Test Prompts.....</b>	<b>5-11</b>
<b>Test Tag Printer .....</b>	<b>5-13</b>
<b>Optional Monitoring Autosequences .....</b>	<b>5-15</b>
<b>Line Voltage Monitor .....</b>	<b>5-16</b>
<b>Environmental Monitor .....</b>	<b>5-17</b>
<b>Toolbox Monitors .....</b>	<b>5-19</b>
<b>Temperature Monitor .....</b>	<b>5-19</b>
<b>Humidity Monitor.....</b>	<b>5-21</b>
<b>6 : C U S T O M I Z E Y O U R M E D T E S T E R</b>	
<b>How to Customize a Preprogrammed Safety Autosequence .....</b>	<b>6-1</b>



<b>What You See in an Autosequence.....</b>	<b>6-2</b>
<b>How to Customize.....</b>	<b>6-3</b>
<b>Customizing a Blank Safety Autosequence .....</b>	<b>6-7</b>
<b>Test Record Header.....</b>	<b>6-7</b>
<b>Customizing Your Autosequence Prompts.....</b>	<b>6-8</b>
<b>Turning Prompts On and Off.....</b>	<b>6-9</b>
<b>Renaming Prompts .....</b>	<b>6-10</b>
<b>Pausing .....</b>	<b>6-11</b>
<b>Test Tag Configuration.....</b>	<b>6-11</b>
<b>Summary of Stored Records.....</b>	<b>6-12</b>
<b>Customizing Bar Code Record Data Entry .....</b>	<b>6-13</b>
<b>Resetting Autosequences to Default Settings.....</b>	<b>6-14</b>
<b>Printing Your medTester 5000C Configuration .....</b>	<b>6-15</b>
<b>Customize medTester 5000C Options.....</b>	<b>6-15</b>
<b>7 : P E R F O R M A N C E W A V E S</b>	
<b>Outputting Performance Waves .....</b>	<b>7-1</b>
<b>Waveform Groups .....</b>	<b>7-2</b>
<b>Running Waveforms from The WAVES Menu.....</b>	<b>7-4</b>
<b>Conducting Waveform Tests in Safety Autosequences.....</b>	<b>7-5</b>
<b>8 : M E M O R Y</b>	
<b>Introduction .....</b>	<b>8-1</b>
<b>Viewing A Single Record .....</b>	<b>8-2</b>
<b>Printing Records .....</b>	<b>8-2</b>
<b>Print A Single Record.....</b>	<b>8-2</b>
<b>Print A Range of Records.....</b>	<b>8-3</b>
<b>Print All Records .....</b>	<b>8-3</b>
<b>Print Records by Type.....</b>	<b>8-3</b>
<b>Printing A Summary of Records.....</b>	<b>8-5</b>
<b>Printing Failed Test Records .....</b>	<b>8-5</b>
<b>Configuring Your Printer.....</b>	<b>8-5</b>
<b>Deleting Records .....</b>	<b>8-6</b>
<b>Erasing Memory, All Records, and Checklists .....</b>	<b>8-6</b>
<b>Checking Contents of Memory .....</b>	<b>8-6</b>
<b>Searching for Records.....</b>	<b>8-7</b>
<b>Searching for Records with Test Failures.....</b>	<b>8-8</b>
<b>Printing Checklists .....</b>	<b>8-8</b>
<b>Keyboard Shortcut Commands.....</b>	<b>8-9</b>
<b>9 : D E F I B R I L L A T O R M O D U L E</b>	
<b>Defibrillator Autosequences.....</b>	<b>9-1</b>
<b>Defibrillator Autosequence Names.....</b>	<b>9-3</b>
<b>Running Defibrillator Autosequence Tests .....</b>	<b>9-5</b>
<b>Pretest Device Prompts.....</b>	<b>9-6</b>

<b>Test Sequence</b> .....	9-7
<b>Posttest Prompts</b> .....	9-12
<b>Customizing Defibrillator Autosequences</b> .....	9-12
<b>Make Your Own Autosequence</b> .....	9-12

## **1 0 : I V P U M P M O D U L E**

<b>IV Pump Autosequences</b> .....	10-1
<b>Basic Test Format</b> .....	10-1
<b>IV Pump Analyzers</b> .....	10-2
<b>IV Pump Autosequence Names</b> .....	10-4
<b>Running IV Pump Autosequences</b> .....	10-7
<b>Select the Autosequence</b> .....	10-7
<b>Pretest Device Prompts</b> .....	10-7
<b>IV PUMP TESTS</b> .....	10-9
<b>Infutest 2000 Series D</b> .....	10-9
<b>IPT-1</b> .....	10-12
<b>IPT-MC</b> .....	10-12
<b>IDA 4 Plus</b> .....	10-13
<b>Pressure Test (Infutest, IPT-1, IPT-MC and IDA 4 Plus)</b> .....	10-17
<b>Posttest Prompts</b> .....	10-18
<b>Customizing IV Pump Tests</b> .....	10-22
<b>Make Your Own Autosequence</b> .....	10-22
<b>Making an Autosequence</b> .....	10-23
<b>Infutest</b> .....	10-23
<b>IPT-1</b> .....	10-25
<b>IPT-MC</b> .....	10-26
<b>Print Your Autosequence</b> .....	10-26
<b>Reinitialize Factory Default Settings</b> .....	10-26

## **1 1 : M E D C H E C K M O D U L E**

<b>Tap Your medTester's Potential</b> .....	11-1
<b>What's a Checklist?</b> .....	11-2
<b>Understanding and Using Checklists</b> .....	11-3
<b>You've Made a Checklist—Now What?</b> .....	11-6
<b>Running Checklists in medTester 5000C</b> .....	11-6
<b>Find a Checklist</b> .....	11-7
<b>Run a Checklist</b> .....	11-7
<b>Items in a Checklist</b> .....	11-9
<b>View or Print a Checklist</b> .....	11-12
<b>Remote Control of Fluke Biomedical Testers</b> .....	11-13

## **1 2 : R E M O T E O P E R A T I O N**

<b>Local Versus Remote Mode</b> .....	12-1
<b>Communicating through medTester Serial Ports</b> .....	12-1
<b>Communications Settings</b> .....	12-2

<b>Local Input Mode .....</b>	<b>12-3</b>
<b>Local Output for Records and Tags .....</b>	<b>12-4</b>
<b>Record Output.....</b>	<b>12-5</b>
<b>Test Tag Output.....</b>	<b>12-5</b>
<b>Remote Mode.....</b>	<b>12-6</b>
<b>Going Remote .....</b>	<b>12-6</b>
<b>File Transfer Protocol.....</b>	<b>12-9</b>
<b>Remote Commands List .....</b>	<b>12-12</b>
<b>Port Diagnostics .....</b>	<b>12-17</b>
<b>1 3 : T H E W E D G E A D A P T E R</b>	
<b>Features of the Wedge .....</b>	<b>13-1</b>
<b>Serial Port Expansion .....</b>	<b>13-2</b>
<b>Keyboard Interface.....</b>	<b>13-2</b>
<b>Port Configuration .....</b>	<b>13-2</b>
<b>Installing the Wedge.....</b>	<b>13-4</b>
<b>Disassembly of the medTester 5000C's Feet and Tilt Bail ...</b>	<b>13-5</b>
<b>Attaching the Wedge to the medTester 5000C.....</b>	<b>13-5</b>
<b>Operating the Wedge.....</b>	<b>13-7</b>
<b>Wedge Port Names .....</b>	<b>13-7</b>
<b>Enabling The Wedge .....</b>	<b>13-7</b>
<b>Configuring Wedge Ports .....</b>	<b>13-7</b>
<b>Configuring One Port for Two Purposes .....</b>	<b>13-11</b>
<b>Setting Baud Rates.....</b>	<b>13-11</b>
<b>Setting Output Ports.....</b>	<b>13-13</b>
<b>1 4 : E S U M O D U L E</b>	
<b>ESU Autosequences .....</b>	<b>14-1</b>
<b>ESU Autosequence Names .....</b>	<b>14-4</b>
<b>Running ESU Autosequence Tests.....</b>	<b>14-5</b>
<b>Pretest Device Prompts.....</b>	<b>14-6</b>
<b>Test Sequence .....</b>	<b>14-7</b>
<b>ESU Test Types.....</b>	<b>14-7</b>
<b>ESU Autosequence Descriptions.....</b>	<b>14-10</b>
<b>Posttest Prompts .....</b>	<b>14-14</b>
<b>Customizing ESU Autosequences .....</b>	<b>14-15</b>
<b>Make Your Own Autosequence .....</b>	<b>14-15</b>
<b>S P O 2 M O D U L E</b>	
<b>SPO2 Autosequences .....</b>	<b>15-1</b>
<b>SPO2 Autosequence Names .....</b>	<b>15-4</b>
<b>Running SPO2 Autosequence Tests.....</b>	<b>15-6</b>
<b>Pretest Device Prompts.....</b>	<b>15-8</b>
<b>Test Sequence .....</b>	<b>15-9</b>
<b>Probe Test.....</b>	<b>15-12</b>

<b>For the Oxitest PLUS:</b> .....	<b>15-13</b>
<b>For CardioSat 100:</b> .....	<b>15-16</b>
<b>For the Index 2XL:</b> .....	<b>15-19</b>
<b>Posttest Prompts</b> .....	<b>15-22</b>
<b>Customizing SPO2 Autosequences</b> .....	<b>15-22</b>
<b>Make Your Own Autosequence</b> .....	<b>15-22</b>
<b>Configuring for Your SPO2 Simulator</b> .....	<b>15-23</b>
<b>Making an Autosequence</b> .....	<b>15-23</b>
<b>16 : T R A N S C U T A N E O U S</b>	
<b>P A C E M A K E R ( P A C E R ) M O D U L E</b>	
<b>Pacer Autosequences</b> .....	<b>16-1</b>
<b>Pacer Autosequence Names</b> .....	<b>16-3</b>
<b>Running Pacer Autosequence Tests</b> .....	<b>16-4</b>
<b>Pretest Device Prompts</b> .....	<b>16-5</b>
<b>Test Sequence</b> .....	<b>16-6</b>
<b>Posttest Prompts</b> .....	<b>16-14</b>
<b>Customizing Pacer Autosequences</b> .....	<b>16-15</b>
<b>Make Your Own Autosequence</b> .....	<b>16-15</b>
<b>17 : N O N - I N V A S I V E B L O O D</b>	
<b>P R E S S U R E ( N I B P ) M O D U L E</b>	
<b>NIBP Autosequences</b> .....	<b>17-1</b>
<b>NIBP Autosequence Names</b> .....	<b>17-3</b>
<b>Running NIBP Autosequence Tests</b> .....	<b>17-4</b>
<b>Pretest Device Prompts</b> .....	<b>17-5</b>
<b>Test Sequence</b> .....	<b>17-6</b>
<b>Posttest Prompts</b> .....	<b>17-11</b>
<b>Customizing NIBP Autosequences</b> .....	<b>17-12</b>
<b>Make Your Own Autosequence</b> .....	<b>17-12</b>

# Chapter 1

## General Information

*In this chapter you will learn how to use this manual, where to get help, and about medTester 5000C Features and Specifications.*

### SAFETY CONSIDERATIONS

#### General

This instrument and related documentation must be reviewed for familiarization with safety markings and instructions before you operate the instrument. Refer to the medTester 5000C Operators Manual for operating instructions.

#### Safety Symbols



The symbol to the left is the operators manual symbol. When you see this symbol on the instrument, refer to the operators manual.

**WARNING!** Denotes a hazard. **WARNING!** calls attention to a procedure, practice, or the like, which, if not correctly performed or adhered to, could result in personal injury. Do not proceed beyond a **WARNING!** sign until the indicated conditions are fully understood and met.

**CAUTION.** Denotes a hazard. **CAUTION** calls attention to a procedure, practice, or the like, which, if not correctly performed or adhered to, could result in damage to or destruction of part or all of the instrument. Do not proceed beyond a **CAUTION** sign until the indicated conditions are fully understood and met.

## **Introduction**

This manual is written for the biomedical technician or clinical engineer responsible for testing hospital equipment, or the plant maintenance technician responsible for maintenance records.

The medTester 5000C is an automated biomedical equipment test system and a portable data acquisition unit that can be controlled with a computer. You can expand the capabilities of the base model by adding modules that let you store test records to memory and print them out.

The medTester 5000C is designed to measure electrical current and resistance as they relate to electrical safety. It measures conditions that might cause injury for compliance with the specifications set forth by ANSI, NFPA, and AAMI.

The medTester 5000C base model automates repetitive tasks with safety autosequences for medical equipment, including lead tests on patient monitors, as well as general electrical devices. You can customize autosequences to meet your specific testing needs.

With the addition of optional modules (for example, the RS-232/Printer module, 100 Record Memory module, Expanded Memory module, and the Waveform/Extended Testing module) your medTester 5000C becomes even more powerful. The Waveform/Extended Testing module gives you additional safety autosequences and performance wave and arrhythmia generation capabilities. Individual defibrillation and IV pump modules offer safety and performance testing autosequences for those devices.

With the Data Transfer module, you can transfer stored equipment test record files to a compatible database program, Computerized Maintenance Management System (CMMS) or Equipment Management System (EMS). The medCheck module enables the downloading of test checklists and the uploading of data to your database, CMMS, or EMS.

Finally, in addition to operating your medTester 5000C in the local mode from the keyboard, bar code port, or the optional external keyboard, you can also operate it from a remote location. Remote operation can take place from a remote personal computer or from a compatible terminal device.

With the Wedge adapter, you can expand the number of serial ports to control several external instruments without changing setups. In addition, you can connect a PC-style keyboard to the Wedge adapter for entering data more easily.

The medTester 5000C—reliable safety and performance testing. Capable of managing your entire equipment program.

## **How to Use This Manual**

Your medTester 5000C Operators Manual is designed for you. Whether you are an experienced medTester operator or someone new to medTester, please read this section before using your medTester 5000C.

### **If You've Used The medTester 5000C Before...**

The medTester 5000C has been substantially upgraded to best satisfy your needs. It now uses a new firmware release that offers increased reliability and more consistent and stable data storage. RAM in the medTester 5000C is dynamic, and data retrieval is simplified. In addition, some features that you may be using have been enhanced with new features for your convenience. Note in particular these chapters:

- Chapter 1 introduces the medTester 5000C's enhanced features.
- Chapter 3 shows you how to navigate the medTester's menus.
- Chapter 6 helps you customize autosequences.
- Chapters 11 and 12 bring you up to date on medCheck checklists remote operation of the medTester 5000C.

### **If You're New to The medTester 5000C...**

Welcome to the medTester 5000C! It is the easy-to-use electrical safety and performance analyzer with a high-quality data collection and retrieval system—all designed to make your job easier and more productive. While the ideal recommendation to a new user is to read the entire manual, we know that you want to start using your new medTester now. Before you do, please review Chapters 1 to 3 to learn about the medTester 5000C. Other chapters of interest to you might be:

- Chapter 4 for information about basic medTester 5000C safety test measurements.
- Chapter 5 for autosequences.

## **Where to Find Help**

If you have questions not answered in this manual, please refer to the following Fluke Biomedical sources:

- medTester 5000C Service Manual, Part No. 2243166.
- Fluke Biomedical Customer Service Department. Telephone 800-648-7952
- *Safe current limits for electromedical apparatus*, (ANSI/AAMI ES1), © 1993, Association for the Advancement of Medical Instrumentation.  
ISBN 1-57020-007-6.  
AAMI Phone: 800-332-2264.
- *Standard for Health Care Facilities*, (NFPA 99), 1993 Edition, © 1993, National Fire Protection Association, February 12, 1993, NFPA.  
NFPA Phone: 800-344-3555.



## Features

The medTester 5000C is an automated biomedical equipment test system designed for you to do electrical safety and performance testing. With the medTester, you can run customizable automatic sequences of tests, called autosequences. You can print stored test records or upload them to a computer. A computer can operate a medTester 5000C from a remote location. This section defines some basic concepts behind the testing that this manual describes.

### Electrical Safety Testing

The medTester 5000C measures electrical current and resistance related to electrical safety. Electrical safety testing is the measurement of electric conditions that could result in injury to operators of that equipment or to patients. All measurements you make with the medTester 5000C comply with specifications set forth by ANSI, NFPA, and AAMI.

### Performance Testing

Performance testing verifies that equipment performs to manufacturer specifications. Different types of medical equipment require tests that are unique to its operation—patient monitors, defibrillators, and IV pumps, to name just a few. The medTester 5000C provides ECG waveforms for performance testing of patient monitors. With optional autosequence modules, you can use analyzers to test the performance of defibrillators, IV pumps, electrosurgical units, pulse oximeter analyzers and more.

### Manual Measurements

You can always perform safety measurements on any electrical equipment directly from the medTester keyboard. Measurements appear on the display continuously until you escape from the test. Instructions for conducting manual tests are in Chapter 4, *Manual Tests*.

### Automatic Measurements

One of the strengths of the medTester 5000C is the ability to automate testing using autosequences. Autosequences are collections of tests that execute as a group. Ten safety autosequences ship with the medTester 5000C base model, each of which you can customize to meet your needs. With the Waveform/Extended Testing Module, you receive an additional five customizable safety autosequences, five ECG performance waveform and arrhythmia groups, and line monitor and environmental autosequences.

Prompts in the autosequence ask you for information that aids in test reporting. The pretest prompts, for example, can ask you for the model and serial number of the equipment you're testing, the test location, operator code, and physical condition of the EUT (equipment under test). Posttest prompts can ask you to schedule the next test date, input comments about the tests, or prepare a test tag.

With the Memory Module and RS-232/Printer Module installed on your medTester 5000C, you can store test records to memory and print them from the medTester's printer port. Additional autosequence modules are available for performance testing defibrillators, IV pumps, and more. See Chapter 5, *Autosequences*.

### **Computer Control**

You can remotely control your medTester 5000C from a personal computer or compatible terminal device through a serial communication port and appropriate communication software. Once connected and in *remote control* of the medTester 5000C, you send remote commands to the medTester 5000C to do safety and performance tests, with the results returned to the computer.

Some medTester 5000C users prefer to accumulate the test data for equipment before reporting stored records. Then at their convenience they upload the data to an equipment database program, Computerized Maintenance Management System, or Equipment Management System (EMS) on a computer. This is accomplished through a serial port on the medTester 5000C and the medTester 5000C's Data Transfer Module. Chapter 12, *Remote Operation*, discusses the methods you can use to control the medTester 5000C and to manage test data.

If you use other Fluke Biomedical analyzers, such as the Impulse 4000 or IPT-1, you can control them with the medTester 5000C. By connecting an analyzer to the medTester 5000C's COM2 port, you gain a two-way communication link. This link lets the medTester 5000C control the operation of the analyzer. Test data that the analyzer collects is then returned to storage in the medTester 5000C.

### **medCheck**

The medTester 5000C medCheck Module unleashes the power of the medTester 5000C to become the centerpiece of a total equipment management solution. medCheck lets you download checklists from, and upload checklist test data to, your equipment management software system.

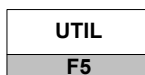
Checklists are complete sets of preventive maintenance procedures for equipment testing. They can contain prompts to the medTester 5000C user to make physical inspections of the EUT and to take individual safety measurements. A checklist can include one or more safety and performance autosequences that automatically execute. Checklist test record data is then uploaded to the user's equipment management database program, Computerized Maintenance Management System. See Chapter 11, *medCheck Module*, for more information.

## medTester 5000C Optional Modules

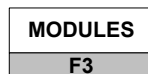
The medTester 5000C offers several modules as options. (See the table later in this chapter.) If your medTester 5000C includes any of these modules, they are listed under the UTIL menu. To access the menu, do the following:

Enter these menu commands:

1. From the main menu, press:



2. Press the right arrow to scroll to the remaining menus.



3. Press:

### NOTE

For further information about using medTester 5000C menus and function keys, see *Navigating the Menus*, in Chapter 3, *Instrument Familiarity*.

Whenever you attempt to select a module that is not installed, this message appears in the display:

MODULE NOT INSTALLED
----------------------

These modules are software enabled for use by the medTester’s firmware. The firmware is held in EPROM (erasable programmable read-only memory). When you purchase one or more of the modules described below, you receive a 3.5-inch floppy diskette containing the software functions of the module. To load the module software, attach the appropriate serial cable from a communications port on your personal computer to a communications port on the medTester.

Once this connection is made, you receive instructions for enabling the module in the medTester 5000C’s EEPROM (electrically erasable programmable read-only memory).

medTester 5000C Modules			
medTester 5000C Module Name	Functions Enabled	medTester Prerequisites for Use of Module	Required for...
RS-232/Printer	<ul style="list-style-type: none"> <li>• Use of COM1 and COM2 serial ports.</li> <li>• Use of the parallel printer port.</li> </ul>	<ul style="list-style-type: none"> <li>• None</li> </ul>	<ul style="list-style-type: none"> <li>• Remote operation of the medTester 5000C from a personal computer or compatible terminal device.</li> <li>• Two-way communication between the medTester 5000C and a Fluke Biomedical analyzer or tester.</li> <li>• Input from an optional keyboard, bar code scanning gun.</li> <li>• Printing test record output.</li> </ul>
Memory—100 Records	<ul style="list-style-type: none"> <li>• Test record storage.</li> </ul>	<ul style="list-style-type: none"> <li>• RS-232/Printer Module</li> </ul>	<ul style="list-style-type: none"> <li>• Storing of test records.</li> </ul>
Memory—Expanded	<ul style="list-style-type: none"> <li>• Storage of autosequence and medCheck data.</li> </ul>	<ul style="list-style-type: none"> <li>• RS-232/Printer Module.</li> <li>• Memory—100 Records Module.</li> </ul>	<ul style="list-style-type: none"> <li>• Autosequence testing.</li> <li>• Use of medCheck.</li> </ul>
Waveform/Extended Testing	<ul style="list-style-type: none"> <li>• Five (5) additional safety autosequences.</li> <li>• ECG performance waveforms.</li> <li>• ECG arrhythmias.</li> <li>• Line monitor test.</li> <li>• Environmental test.</li> </ul>	<ul style="list-style-type: none"> <li>• RS-232/Printer Module.</li> <li>• Memory—100 Records Module.</li> </ul>	<ul style="list-style-type: none"> <li>• Adding more customized safety autosequences.</li> <li>• Outputting ECG waveforms to patient monitors.</li> <li>• Outputting ECG arrhythmias to patient monitors.</li> <li>• Periodic measurements of line voltage.</li> <li>• Measuring ground potential and resistance between a common ground point and multiple points in a room.</li> </ul>

medTester 5000C Modules			
medTester 5000C Module Name	Functions Enabled	medTester Prerequisites for Use of Module	Required for...
Data Transfer	<ul style="list-style-type: none"> <li>File Transfer Protocol used to transfer checklists into and out of the medTester 5000C.</li> </ul>	<ul style="list-style-type: none"> <li>RS-232/Printer Module.</li> <li>Memory—100 Records Module.</li> </ul>	<ul style="list-style-type: none"> <li>Checklist usage.</li> </ul>
medCheck	<ul style="list-style-type: none"> <li>Checklists</li> </ul>	<ul style="list-style-type: none"> <li>RS-232/Printer Module.</li> <li>Memory—100 Records Module.</li> <li>Expanded Memory Module.</li> <li>Data Transfer Module.</li> </ul>	<ul style="list-style-type: none"> <li>Communicating checklists between an equipment management database system and the medTester 5000C.</li> </ul>
Defibrillator	<ul style="list-style-type: none"> <li>Defibrillation autosequences.</li> </ul>	<ul style="list-style-type: none"> <li>RS-232/Printer Module.</li> <li>Memory—100 Records Module.</li> <li>Expanded Memory Module.</li> <li>Data Transfer Module.</li> </ul>	<ul style="list-style-type: none"> <li>20 autosequences for testing defibrillators with the Fluke Biomedical Impulse 4000 defibrillator analyzer.</li> <li>Including defibrillator autosequences in checklists.</li> </ul>
IV Pump	<ul style="list-style-type: none"> <li>IV Pump autosequences.</li> </ul>	<ul style="list-style-type: none"> <li>RS-232/Printer Module.</li> <li>Memory—100 Records Module.</li> <li>Expanded Memory Module.</li> <li>Data Transfer Module.</li> </ul>	<ul style="list-style-type: none"> <li>10 autosequences for testing IV pumps with the Fluke Biomedical pump tester.</li> <li>Including IV pump autosequences in checklists.</li> </ul>
ESU	<ul style="list-style-type: none"> <li>ESU autosequences.</li> </ul>	<ul style="list-style-type: none"> <li>RS-232/Printer Module.</li> <li>Memory—100 Records Module.</li> <li>Expanded Memory Module.</li> <li>Data Transfer Module.</li> </ul>	<ul style="list-style-type: none"> <li>10 autosequences for testing electrosurgical units with Fluke Biomedical analyzers.</li> <li>Including ESU autosequences in checklists.</li> </ul>

medTester 5000C Modules			
medTester 5000C Module Name	Functions Enabled	medTester Prerequisites for Use of Module	Required for...
SPO2	<ul style="list-style-type: none"> <li>SPO2 autosequences.</li> </ul>	<ul style="list-style-type: none"> <li>RS-232/Printer Module.</li> <li>Memory—100 Records Module.</li> <li>Expanded Memory Module.</li> <li>Data Transfer Module.</li> </ul>	<ul style="list-style-type: none"> <li>10 autosequences for testing SPO2 monitors with Fluke Biomedical analyzers.</li> <li>Including SPO2 autosequences in checklists.</li> </ul>
Pacer	<ul style="list-style-type: none"> <li>Transcutaneous Pacemaker autosequences.</li> </ul>	<ul style="list-style-type: none"> <li>RS-232/Printer Module.</li> <li>Memory—100 Records Module.</li> <li>Expanded Memory Module.</li> <li>Data Transfer Module.</li> </ul>	<ul style="list-style-type: none"> <li>10 autosequences for testing transcutaneous pacemakers with the Fluke Biomedical Impulse 4000.</li> <li>Including Pacer autosequences in checklists.</li> </ul>
NIBP	<ul style="list-style-type: none"> <li>Non-Invasive Blood Pressure autosequences.</li> </ul>	<ul style="list-style-type: none"> <li>RS-232/Printer Module.</li> <li>Memory—100 Records Module.</li> <li>Expanded Memory Module.</li> <li>Data Transfer Module.</li> </ul>	<ul style="list-style-type: none"> <li>10 autosequences for testing Non-Invasive Blood Pressure monitors with the Fluke Biomedical CuffLink.</li> <li>Including NIBP pump autosequences in checklists.</li> </ul>
Bar Code (hardware)	<ul style="list-style-type: none"> <li>Scanning of bar code data into test record.</li> </ul>	<ul style="list-style-type: none"> <li>None</li> </ul>	<ul style="list-style-type: none"> <li>Scanning of data.</li> </ul>

## **Features**

- Fully automated electrical safety testing
- 12-lead ECG/arrhythmia simulation
- Dedicated “autosequence” testing for performance testing of defibrillators, infusion pumps, etc.
- 20-ampere testing with GFCI protection
- Meets ANSI/AAMI ES1–1993 test load requirements
- Load current measurement
- Programmable test limits
- Automatic record storage
- Bar code compatibility

## **Optional Accessories**

- External RS-232 Keyboard
- Bar Code Scanner (requires Wedge adapter)
- Wedge Adapter (eight 25-pin serial ports as well as AT or PS/2 keyboard port)
- Mini PC-Style Keyboard (AT or PS/2, requires Wedge adapter)
- Label Printer

## medTester 5000C Instrument Specifications

### Line Voltage and Measurements

- Hot to Neutral.
- Neutral to Ground.
- Hot to Ground.
- Range: 200.0 V RMS.
- Accuracy:  $\pm 5\%$  of range.

### Leakage Current

Leakage current is measured through a 1 k $\Omega$  AAMI load RMS or DC measured and displayed in microamperes. These tests can be thought of as measuring the voltage, in millivolts across the same load.

### Leakage Current Measurements

- Case external.
- Case internal.
- External.
- ECG—Leads are RL, RA, LA, LL, and V1-V6 tied together:
  1. To ground, all leads or individual leads.
  2. Lead to lead, individual leads to all other leads together.
  3. Lead isolation (RMS only), all leads or individual leads.  
This test is with line voltage applied from the lead(s) to ground, current limited by 120 k $\Omega$ .

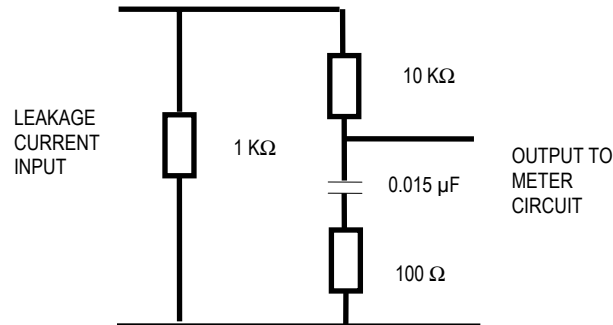
#### Note

If you receive abnormally high leakage current measurements with V1-V6 leads tied together, you can inspect individual V leads by removing the other leads. This procedure allows you to isolate the lead with a high leakage current reading.



### AAMI Load

- Simulated patient load recommended by the Association for the Advancement of Medical Instrumentation (AAMI), Safe Current Limits Standard (ANSI/AAMI ES1-1993) (revision of the earlier ANSI/AAMI ES1-1985 and SCL-12/78).
- AAMI Load drawing:



- Frequency Response: ANSI/AAMI ES1-1993
- Test Load Impedance: 1000 ohms +/- 1% @ DC (ANSI/AAMI ES1-1993)
- Ranges—2000 μA and 200 μA.
- Range—20.00 A RMS.
- Accuracy—± 1.0% of reading DC and from 48 Hz to 1kHz  
± 2.5% of reading 1 kHz to 100 kHz  
± 5.0% of reading 100 kHz to 1 MHz

### Equipment Current

Equipment current measures the current used by the EUT plugged into the test receptacle:

- Range—20.00 A RMS.
- Accuracy—±5% of range.

### Resistance

Resistance tests measure resistance with the four-terminal test method:

- Measurements—Power cord and external.
- Range—2 Ω.
- Accuracy—±1% of range.
- Test Current—100 mA

### Isolated Power

This feature allows the use of the Fluke Biomedical Model 202A Isolation Test Module to make current measurements on an isolated power system. For more information, see Chapter 4, *Manual Tests*.

## **Toolbox**

Toolbox allows for the use of external measurement adapters for:

- Tachometer—with a range of 100 to 20,000 RPM.
- Temperature—with a range of 0 to 200°F or 0 to 100°C.
- Humidity—ranging from 15% to 90% relative.

For more information about Toolbox, see Chapter 4, *Manual Tests*.

## **Test Receptacle**

The medTester 5000C has a test receptacle on the top panel into which the equipment under test (EUT) is plugged. The test receptacle supplies power to the EUT. The EUT must be powered through the test receptacle whenever you measure the following:

- Leakage current—All case and ECG lead measurements.
- Equipment current.
- Power cord resistance.

Test receptacle power is normal except during case and ECG leakage tests (not including isolation tests). For these tests you can set the power to the following conditions, each of which is indicated by annunciator LEDs on the top panel:

- Ground—closed or open.
- Polarity—normal or reversed.
- Neutral—closed or open.

### **Note**

During case internal leakage, ground is always open.

Current is supplied at a maximum instantaneous level of 20 amps.

## **CSA Label**

On the back of the medTester 5000C, you can see a label which specifies the conditions under which the test receptacle can operate:

- 1840 VA, 16 A continuous operation.
- Up to 19 A for no longer than two (2) minutes. Then powered off for eight (8) minutes (20 percent of duty cycle).

## Ground Fault Circuit Interrupter

The test receptacle is protected by a ground fault circuit interrupter. In the event of a fault in the EUT (when the test receptacle is powered on) which causes a current imbalance in the hot and neutral lines of greater than 5 mA, the interrupter triggers. Under this condition, the interrupter turns off the test receptacle and all test connections, and the medTester prompts you to correct the fault and continue.

## Performance Waveforms

The medTester 5000C generates ECG waves and arrhythmias to test the performance of patient monitors in those medTesters that have the Waveform/Extended Testing Module installed. You can find information about conducting waveform tests in Chapter 7, *Performance Waves*. Specifications for waveforms and arrhythmias are:

### ECG Performance Test Waves (Lead I, Vp-p)

- Square Wave—2 Hz, 1 mV
- DC Pulse—4 Seconds, 1 mV
- Sine Wave—0.5, 10, 40, 60, and 100 Hz, 1 mV
- Square Wave—1 kHz, 1 mV
- Triangle—2 Hz, 1 mV
- CMRR—60-Hz sine wave with 1-k $\Omega$  imbalance in LA
- Normal Sinus—30, 60, 120, 240 BPM.

### Arrhythmias

- Atrial fibrillation
- Second degree A-V Block, Type 1
- Premature atrial contractions
- Missed beat at 80 and 120 BPM
- PVC 1 left
- PVC 2 right
- Multifocal PVCs
- PVC 1, R on T
- A pair of PVCs
- Run of 5 PVCs
- Run of 11 PVCs, MF
- Right bundle branch block
- Ventricular tachycardia
- Ventricular fibrillation
- Asystole

## General Specifications

Parameter	Specification
-----------	---------------

Power Requirement:	115 V $\pm$ 10%, 60 Hz only
Temperature Ranges:	Operating: 15° to 35°C (59° to 95°F) Storage: 0° to 50°C (32° to 122°F)
Display:	80-character (40 x 2 lines) backlit Liquid Crystal Display
Weight:	5 kg (11 lb)
Dimensions:	25.4 cm L x 35.0 cm W x 10.2 cm H (10 in L x 13.8 in W x 4 in H)

### ECG Connections

Waveforms generated for performance testing can be output through the binding posts on the medTester 5000C's top panel or the ECG High-Level Output located on the medTester 5000C's back panel.

### ECG Binding Posts

- 10 posts, American Hospital Association color-coded,
- RL, RA, LA, LL, V1-V6,
- Compatible with both 3.2-mm and 4.0-mm pins and disposable snap electrodes.

### High-Level ECG Output

- ¼" phone jack,
- 1-volt nominal.

### Data Input and Output

- Top panel keyboard (QWERTY-type)—48 characters.
- Bar code reader (optional).
- RS-232C serial ports (2) for computer interface or auxiliary test instrument control, expansion to an additional eight (8) ports with the Wedge Adapter.
- Parallel printer port (1).

### RS-232C Serial Interface Parameters

- Baud—300, 600, 1200, 2400, 4800, 9600, 19200.
- Stop Bits—1.
- Parity—Off.
- Data Length—8 bits.

### Real Time Clock

Real time clock is kept internal to the instrument.

## Accessories

<b>Standard</b>	<b>Part #</b>
• 20/15–amp Adapter	2195732
• Two Kelvin Cable	2392617
• Two Ground Pin Adapters	2242165
• Operator Manual	2243153
• Accessory Pouch	2392871
<b>Optional</b>	<b>Part #</b>
• Interface Cable, medTester to PC	RS-232; Female DB25 to Female DB25 2392186
• Interface Cable, medTester 5000C to Patient Simulator	RS232; Right Angle DIN to Female DB25 2200808
• Interface Cable, AT-Style PC Adapter Cable	RS232; DB9 to DB25, for use w/2392186 2199233
• Interface Cable, medTester to Impulse 3000	RS232, Straight DIN to Female DB25 2199346
• Interface Cable, medTester to Impulse 4000	RS232; Female DB25 to Female DB25 2200252
• Interface Cable, medTester to Oxitest Plus/Plus7	RS232; Female DB25 to mini DIN 2237730
• Interface Cable; medTester to Infutest 2000 Series D	RS232; Female DB25 to Female DB25 2237604
• Interface Cable; medTester Wedge to IDA 4 Plus	RS232; Female DB9 to Female DB25 2201042
• Interface Cable; medTester to RF303RS. Requires adapter 2391789.	RS232; Male DB9 to Female DB9 2238659
• Adapter; for medTester to RF303RS with 2238659	Adapter; Male DB9 to Female DB25 2391789
• Interface Cable, medTester to PC/454A/CuffLink; Impulse 4000 to PC	RS232; Female DB25 to Female DB25 2392186
• Interface Cable, medTester to SigmaPace™ 1000/402A/PC/IPT-MC/Index 2XL/IDA 4 Plus (IDA 4 Plus to Wedge use 2201042); Impulse 4000 to PC	RS232; Female DB25 to Female DB9 2200102
• Interface Cable, medTester to IPT-1	RS232; Female DB25 to Male DB25 2392251
• Interface Cable, medTester to IPT-MC	RS232; Female DB25 to Female DB9* 2201042
• Printer Cable, medTester to TLP-1 & TLP-2 Test Label Printer	Serial Cable; 2200717

<b>Optional (continued)</b>	<b>Part #</b>
• Printer Cable, medTester to standard PC printer	Serial Cable; Male DB25 to Centronics 2200577
• TLS Test Tag Printer Kit	Printer, white and yellow vinyl labels, black vinyl printer ribbon, serial cable, adapter and US power source 2245515
• TLP-1/2 Printer Paper, Yellow	2220045
• TLP-1/2 Printer Paper, Blue	2220038
• TLP-1/2 Printer Paper, White	2220023
• TLS Label Roll Vinyl White	2243893
• TLS Label Roll Vinyl Yellow	2243902
• TLS Label Roll Vinyl Orange	2243916
• TLS Label Roll Vinyl Red	2243925
• TLS Label Roll Vinyl Blue	2243933
• TLS Label Roll Vinyl Green	2243940
• TLS Printer Ribbon Vinyl Black	2243957
• Adapter DB-9 M to DB-25 F	2391789
• Service Manual	2243166
• Wedge Adapter	2245264
• PC Wedge Laser Barcode Gun	2245092
• Mini PC-style Keyboard	2245061
• Multi-purpose Hard-Sided Carrying Case (contains "Pick & Pluck" foam)	Fits medTester with Wedge (29" L x 18" W x 10½" H) 2248606
• Multi-purpose Hard-Sided Carrying Case (contains "Pick & Pluck" foam)	Fits medTester without Wedge (19" L x 14" W x 7¾" H) 2248587

\* Part #2200102 will interface with the IPT-MC directly for the medTester ONLY.  
 Part #2201042 will interface with the IPT-MC directly to medTester OR through the Wedge accessory.

**medTester 5000C Module Upgrades**

**Part #**

**Factory Installed**

● Module 2, Service, RS-232/Printer	2246094
● Module 3, Service, 100 Records	2246100
● Module 4, Service, Expanded Memory	2246117
● Module 5, Service, Waves/Extended Test	2246121
● Module 6, Service, Data Transfer	2246139
● Module 7, Service, medCheck	2246142
● Module 8, Service, Defibrillator	2246156
● Module 9, Service, IV Pump, IPT	2246163
● Module 10, CMMS Interface	2246174
● Module 11, Service, ESU	2246188
● Module 12, Service, SPO2	2246195
● Module 13, Service, Pacer	2246206
● Module 14, Service, NIBP	2246214

**Field Installed**

● Module 2, Field, RS232/Printer	2246238
● Module 3, Field, 100 Records	2246245
● Module 4, Field, Expanded Memory	2246250
● Module 5, Field, Waves/Extended Test	2246261
● Module 6, Field, Data Transfer	2246277
● Module 7, Field, medCheck	2246289
● Module 8, Field, Defibrillator	2246292
● Module 9, Field, IV Pump, IPT	2246303
● Module 10, Field, CMMS Interface	2246315
● Module 11, Field, ESU	2246326
● Module 12, Field, SPO2	2246332
● Module 13, Field, Pacer	2246344
● Module 14, Field, NIBP	2246359





# Chapter 2 Installation

*In this chapter you will find information about the default (factory) settings, power-up sequence, setting the time and date, and using the beeper.*

## Factory Default Settings

The medTester 5000C is shipped from the Fluke Biomedical factory with the settings described below.

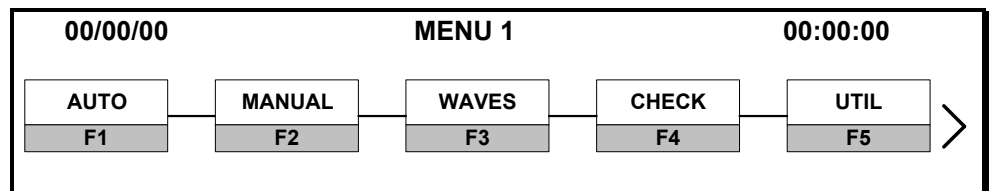
FACTORY DEFAULT SETTINGS	
Condition Name	Default Setting(s)
Headers	<ul style="list-style-type: none"><li>• All headers are cleared.</li><li>• Header #1 is set to active.</li></ul>
Prompts	<ul style="list-style-type: none"><li>• All prompts are set to ON.</li><li>• Renameable prompts set to the default names: CONTROL#, SERIAL#, PHYSICAL INSPECTION#, COMMENTS.</li></ul>
Pause	<ul style="list-style-type: none"><li>• Set to none.</li></ul>
Tag	<ul style="list-style-type: none"><li>• All items set to ON.</li></ul>
Record Summary	<ul style="list-style-type: none"><li>• Fields are set with the following name and character width:<ul style="list-style-type: none"><li>• CONTROL#, 12 characters</li><li>• MANF, 12 characters</li><li>• MODEL, 12 characters</li><li>• SERIAL#, 12 characters</li><li>• LOC, 12 characters</li><li>• OP CODE, 3 characters</li></ul></li></ul>
Bar Code	<ul style="list-style-type: none"><li>• All prompts set for single entry.</li></ul>
Stored entries	<ul style="list-style-type: none"><li>• OP CODE, LOC, NEXT TEST DUE DATE are cleared.</li></ul>
Baud Rates	<ul style="list-style-type: none"><li>• Both COM ports set to 9600.</li></ul>
Temperature Scale	<ul style="list-style-type: none"><li>• Set to Fahrenheit scale.</li></ul>

FACTORY DEFAULT SETTINGS	
Condition Name	Default Setting(s)
Output	<ul style="list-style-type: none"> <li>RECORD and TAG output set to:               <ul style="list-style-type: none"> <li>COM1-OFF</li> <li>COM2-OFF</li> <li>PRINTER-ON</li> </ul> </li> </ul>
Printer Page	<ul style="list-style-type: none"> <li>Set to 60 lines for records.</li> <li>Set to 5 lines for tags.</li> </ul>
Beeper	<ul style="list-style-type: none"> <li>KEYS set to three (3).</li> <li>ALERT set to six (6).</li> </ul>
Memory	<ul style="list-style-type: none"> <li>Erased for both test records and checklists.</li> </ul>
Wedge Adapter	<ul style="list-style-type: none"> <li>Disabled</li> </ul>

## Power-Up Sequence

When you turn on the medTester 5000C, the following power-up sequence takes place:

1. **Introductory Message**—These items below appear in the medTester 5000C display:
  - The text FLUKE BIOMEDICAL MEDTESTER 5000C.
  - The serial number.
  - The firmware version number.
2. **Tests**—The medTester tests the condition of its internal battery and the condition of the line voltage into which the medTester 5000C is connected. A message appears on the medTester display **only** if the medTester detects an irregular condition. See the list of error messages and conditions below. After the message appears, you can press F5 CONTINUE to continue any remaining tests. If no message displays, menu one appears similar to this one:



medTester 5000C Power-Up Condition Messages	
Message	Condition Indicated
LOW BATTERY, SERVICE REQUIRED!	Internal battery (used for memory and clock backup) level is low.
LOW LINE VOLTAGE!	Hot to neutral is less than (<) 90 V.
HIGH LINE VOLTAGE!	Hot to neutral is greater than (>) 135 V.
OPEN GROUND OR ISOLATED POWER SYSTEM!	Hot to ground differs from neutral to ground by more than 50 V.
REVERSE POLARITY OUTLET!	Neutral to ground is greater than (>) 70 V and hot to ground less than (<) 35 V.

## Initialization

You can initialize your medTester with two different local keyboard commands which you can type at the main menu.

- **INIT + Enter**—Initializes autosequences and custom features with YES or NO prompts for each section. This initialization command does not erase test records or checklists from memory
- **INITALL + Enter**—Initializes the entire instrument with no exceptions. All test records and checklists are erased from memory with this option.

## Date and Time Setup

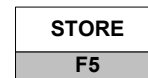
Date uses the *month/date/year* format, and time uses the *hour:minute:second* format. Note that time is entered in the 24-hour format. To reset the date and time:

1. Enter menu commands:  
See note below.



2. Enter the date and time directly from the keyboard, or...  
Use the keyboard left and right arrow keys to move to the desired month/date/year or hour/minute/second data entry point.
3. Enter the desired data from the keyboard, or use the up/down keys to increment or decrement the data.

4. After entering date and time, insert a thin, non-metallic device in the “clock set enable switch” slot (labeled on the right side of the medTester) to depress the switch and enter the following menu



command to store this information:

Press **Esc** to escape this procedure and to keep current settings.

### Note

There is an INIT, F4, menu to initialize the date and time of a new instrument. The “clock set enable switch” must be pressed as in step 4 above, to save this initialization.

## Audio Transducer

The medTester 5000C comes with an audio transducer that beeps whenever data is entered from the keyboard or during an alert situation. You can adjust the volume of the beeper:

1. Enter menu commands:



2. To change the beeper volume of keyboard entries or to change

the volume of an alert, press either

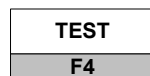


or

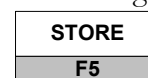
3. Press
4. Test the beeper level by entering the menu command:



to increase the volume to the desired level for keys or alert, depending upon which beeper key you pressed above. Volume Levels are 0-6 with 0 inaudible and 6 the loudest.



5. After entering beeper volume, enter the following menu



command to store this information:

Press **Esc** to escape this procedure and to keep current settings.

## Enabling Modules

If it should become necessary to reinstall modules 2 through 14, perform the steps described below. You need to install each module from its separate diskette. Installation requires running a program on an IBM-compatible personal computer.

### Note

You **MUST** install the modules that you have received in numerical order, starting with Module 2, or the lowest numbered module you have. Installing modules in numerical order will lead to a successful installation.

1. Use the medTester 5000C COM1 port.
2. Decide on a computer COM port—(COM1 through COM4).
3. Decide on a baud rate—(300, 600, 1200, 2400, 4800, 9600, or 19200).
4. To change the medTester baud rate from MAIN MENU 1:
  - A. Press F5 UTIL, then F1 BAUD;
  - B. Select the COM1 port;
  - C. Press F4 BAUD until the desired baud rate is displayed;
  - D. Press F5 STORE; Press Esc twice to return to MAIN MENU 1.

### Note

If Module 2 (RS-232/Printer) has not yet been installed, the medTester baud rate is not selectable and can not be adjusted. It is permanently set to 9600. After you install Module 2, you can change the baud rate.

5. Connect the computer COM port to the medTester COM1 port (medTester to PC null modem serial cable).
6. Run the computer in DOS mode (command prompt).

**Note**

If running Windows 95 or 98, with the mouse you can click and hold the Start button, then select *Programs* and *MS-DOS Prompt*.

If running Windows 2000 or XP, with the mouse click the Start button, select *Programs*, *Accessories*, and *Command Prompt*.

7. Insert the diskette into the computer's 3.5" floppy disk drive.
8. At the DOS prompt type this command:  
**A:\INSTALL port baud <Enter>**  
 Where **A** is the floppy disk drive letter, A or B, and **port** is the computer COM port, 1 through 4, and **baud** is the selected baud rate: 300, 600, 1200, 2400, 4800, 9600, or 19200.

Here's an example of this command:

**A:\INSTALL 1 9600<Enter>**

9. The program will install (enable) the module in the medTester. The computer should display **MODULES SUCCESSFULLY LOADED**.

Note: If you have problems or get a different message, you can read the **README** file by typing **A:README<Enter>** for suggestions.

Modules are customized for each instrument and can only be installed on the instrument with that specific serial number. Some modules need prerequisite modules to be installed first.

**MODULE PREREQUISITE REQUIREMENTS**

<b>Module</b>	<b>Description</b>	<b>Prerequisite</b>
2	RS232 / Printer	None
3	100 Record Storage	Module 2
4	Expanded Record Storage	Modules 2 & 3
5	Waveforms / Extended Testing	Modules 2 & 3
6	Data Transfer	Modules 2 & 3
7	MedCheck	Modules 2, 3, & 4
8	DEFIB Autosequences	Modules 2,3, & 4
9	IVPUMP Autosequences	Modules 2,3, & 4
10	Competitive CMMS Interface	Modules 2,3,4,6 & 7
11	ESU Autosequences	Modules 2,3, & 4
12	SPO2 Autosequences	Modules 2,3, & 4
13	PACER Autosequences	Modules 2,3, & 4
14	NIBP Autosequences	Modules 2,3, & 4

- 10.** To install more than one module, repeat steps seven (7) through nine (9) for each module which has an installation disk. Install them in numerical order.
- 11.** If necessary, return to Windows from Command Prompt by typing: **EXIT<Enter>** at the DOS prompt.

### **Confirming Module Installation**

- 1.** Turn the medTester 5000 power off to reset the microprocessor.
- 2.** Turn the medTester 5000 power on. Check that the startup message shows the correct instrument serial number and the correct firmware version number.
- 3.** Push F5 UTIL, then right arrow, then F3 MODULES. At this point, each press of F5 NEXT will sequentially scroll through each installed module allowing you to confirm the modules installed in the medTester 5000.





# Chapter 3

## Instrument Familiarity

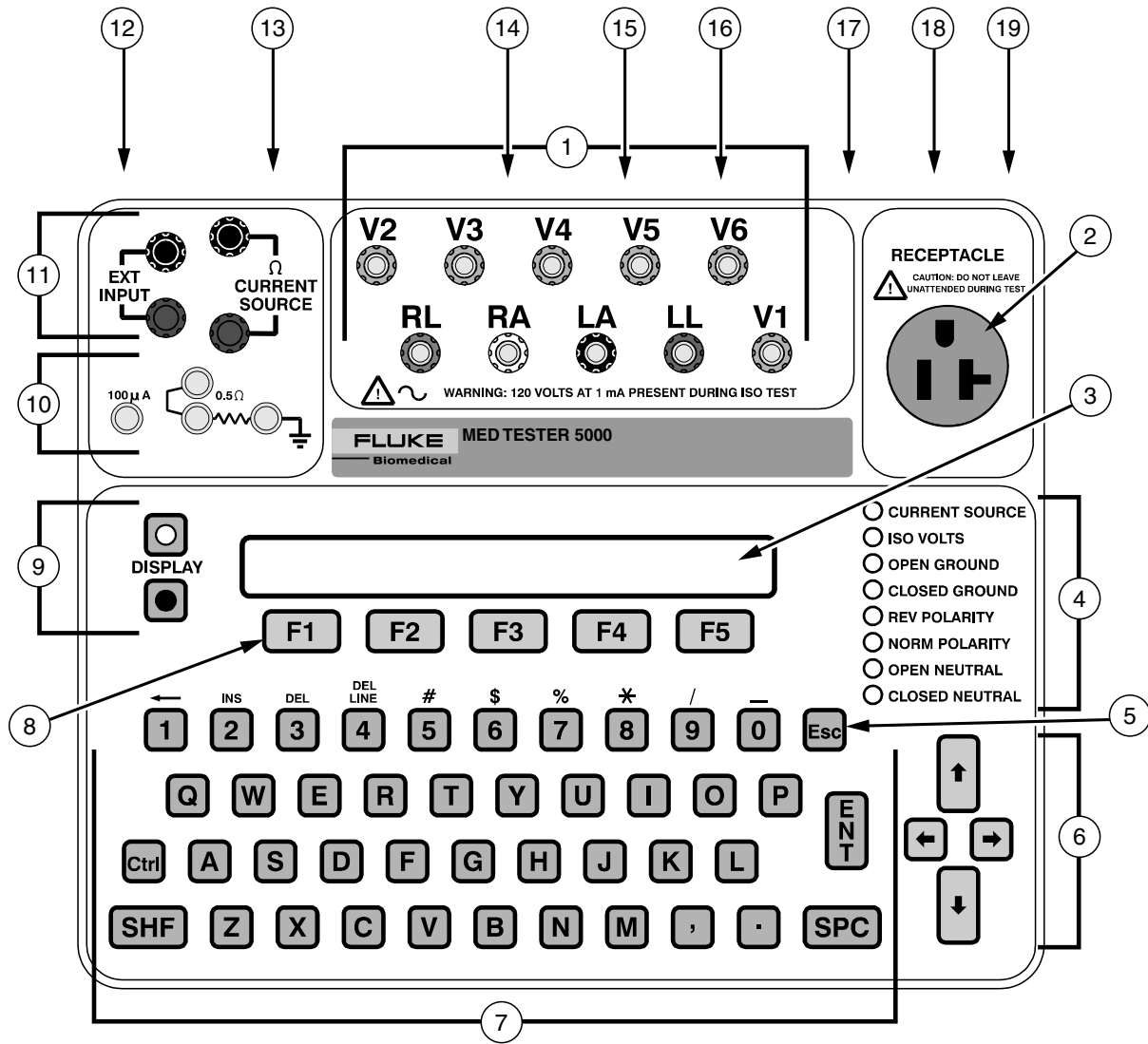
*This chapter familiarizes you with the medTester 5000C.*

### Know Your medTester 5000C

The medTester 5000C has two major control and interface sections—the top panel and the rear panel. Below is a list of the controls, displays, and connectors on these two panels. The numbers in the list refer to the locations in Figure 3-1.

#### Top Panel Controls, Displays, and Connectors

- 1. ECG LEADS Binding Posts**—There are ten binding posts used for ECG leads whenever you test a device with patient leads. Connect the patient leads to these posts. These posts accept snap connectors, and you can unscrew the sleeves to expose a 4-millimeter (mm) hole to which you attach diagnostic pin electrodes or banana plugs.
- 2. TEST RECEPTACLE**—Power receptacle for the equipment under test (EUT).
- 3. DISPLAY**—The LCD display contains two lines of 40 characters each. See number nine (9) in this list.
- 4. DISPLAY ANNUNCIATORS**—Eight LEDs, which when lit, indicate coinciding test status conditions; that is CURRENT SOURCE, ISO VOLTS, OPEN GROUND, CLOSED GROUND, REV POLARITY (reversed polarity), NORM POLARITY (normal polarity), OPEN NEUTRAL, and CLOSED NEUTRAL.
- 5. ESCAPE KEY**—Used to return to a previous menu or to abort an operation.



**Figure 3-1.** MedTester 5000C Top and Rear Panel Locator

- 6. ARROW KEYS**—Control cursor movement when entering data into the display from the keyboard and scroll through menus horizontally. See *Navigating the Menus* later in this chapter.
- 7. KEYBOARD**—Standard QWERTY-type keyboard with numeric characters 0-9 and full alpha character list. The spacebar key is positioned at the lower right-hand corner, and there is one shift key and one control key. Special editing keys are located at the SHF+KEY positions of numbers 1-4; for example, SHF+2 keys to insert.
- 8. FUNCTION KEYS**—Five function keys, F1 through F5. Used to select menus, menu commands, and menu options. See *Navigating the Menus* later in this chapter.
- 9. DISPLAY KEYS**—Two keys, one white and one black. Pressing the white key increases the display brightness. Pressing the black key decreases the display brightness. Pressing these keys also changes the viewing angle.
- 10. TEST POINTS**—Four test points including a 100- $\mu$ A test point, two 0.5-ohm test points, and one ground stud.
- 11. EXTERNAL METER POSTS**—Two pair of red and black binding posts. One for external input (EXT INPUT) measurements. One for a 100-mA CURRENT SOURCE used for resistance measurements.

### **Rear Panel Controls, Displays, and Connectors**

- 12. BAR CODE PORT**—For use with the optional bar code reader wand.
- 13. PRINTER PORT**—For use with printers compatible with personal computers.
- 14. COM2 PORT**—Receives input locally from the optional keyboard, bar code scanning gun, or personal computer or terminal. Outputs data to a personal computer or terminal. Also used by the medTester 5000C for two-way communication with other Fluke Biomedical test devices and for data output to personal computers or a serial terminal. See Chapter 12, *Remote Operation*. With a Wedge adapter, this port is expanded to eight ports on the Wedge.
- 15. HIGH-LEVEL ECG OUTPUT**—A 1/4" telephone jack with a Lead I waveform at 1 V/mV of the low-level Lead I signal.

**16. COM1 PORT**—Receives input locally from the optional keyboard, bar code scanning gun, or personal computer or terminal. Outputs data to a personal computer or terminal. With a Wedge adapter, this port is used by the external PC keyboard interface.

**17. FUSE**—Twenty (20) ampere, slow-blow type, 250 V.

**18. POWER SWITCH**—Powers the medTester 5000C on or off.

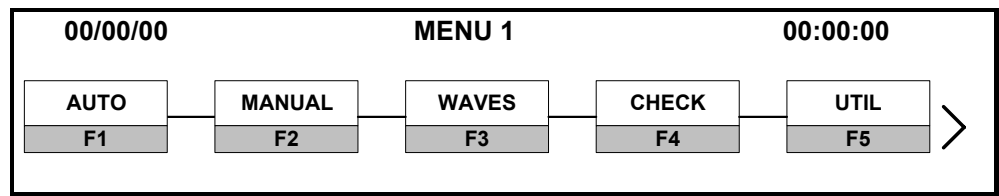
**19. POWER CORD and PLUG**—The hardwired power plug is a 20A configuration. For most testing leave the 20A to 15A adapter plug on to plug into a 15A outlet.

### Power Up

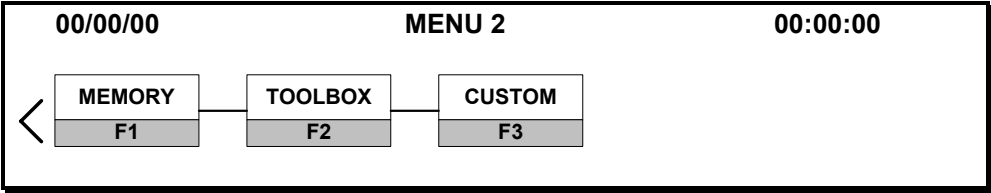
Locate the power switch on the rear panel, and power on the medTester 5000C. The name and revision appear followed by the main menu. To darken or lighten the display, use the DISPLAY keys to the left of the display. The black-circled key darkens the display. The white-circled key lightens the display.

### Navigating the Menus

Operating the medTester 5000C is as easy as pressing the function key on the top panel that corresponds to the desired menu item in the display. There are five function keys marked F1 through F5 below the display (see the figure below). The function keys select the menu functions that appear in the display just above them. The medTester 5000C is operated through menu choices in a tree-like structure. When you power on the medTester, the first menu you see sits at the top of the tree. As you make menu choices, you move to lower levels, or branches, of the tree. The menu you see below is the main menu.



Note the right arrow located at the right edge of the menu. Whenever you see a right arrow on a menu, it indicates that there are more menu items at the same level. Access those items by pressing the right arrow key on the keyboard. What you then see on the display is:



The display now shows menu two. Remember that menu two is an extension of menu one. Menu-two menu items are at the same level as menu one items. Menu two contains a left arrow which indicates that there are menu items which you can scroll to by using the left arrow key. Pressing the left arrow returns you to menu one.



# Chapter 4

## Manual Tests

*Learn to use the medTester 5000C to manually perform electrical safety tests for line voltage, leakage current, equipment current, and resistance.*

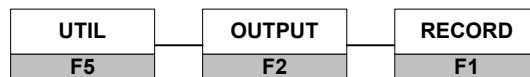
### Performing Manual Tests

The medTester 5000c has all the features of a manual safety tester. You can access these features from the items under **MANUAL** on Menu 1.

### Printing Manual Measurements

With the RS-232/Printer module installed, you can print any manual measurement result. Results print out on a single line. To print manual measurements with the measurement displayed on the medTester, press : Ctrl+P.

The current measurement prints through the port that you activate from the UTIL menu:



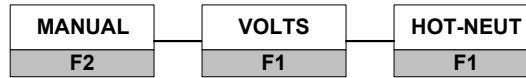
### Line Voltage

See Figure 4-1, *Three Types of Line Voltage Measurements*.

Three line voltage measurements are available within a range of 0-200 volts RMS with an accuracy of  $\pm 5\%$  of the range.

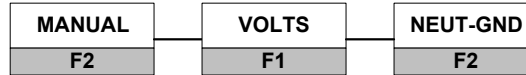
### Hot to Neutral

Enter menu commands:



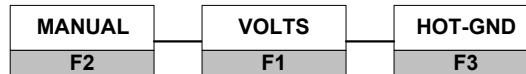
### Neutral to Ground

Enter menu commands:



### Hot to Ground

Enter menu commands:



### Leakage Current

All leakage current measurements are taken through a 1-k $\Omega$  AAMI load RMS or DC. Current is measured in a range of 2000  $\mu$ A or 200  $\mu$ A.

#### Note

These tests are described using Kelvin cables for connections. However, single-wire test cables can be used. Connect single-wire test cables to the external input posts only.

#### Note

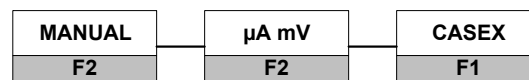
For all leakage current measurements, except ECG lead isolation, DC toggles the measurement between RMS and DC.



### External Case Leakage

See Figure 4-2, *Case External Leakage*.

1. Plug the EUT (equipment under test) into the test receptacle.
2. Connect the dual banana-plug end of a Kelvin cable to the two **red** external meter posts.
3. Connect the alligator-clip end of the Kelvin cable to a grounded point on the case of the equipment under test.
4. Enter menu commands:



5. Select the desired condition:
  - **GROUND**—closed or open,
  - **POLARITY**—normal or reversed,
  - **NEUTRAL**—open or closed.

The respective condition LEDs light, and the display reads the current leakage in  $\mu\text{A}$ .

External leakage current is the current that flows from the case of the equipment under test to earth ground. The current flowing from the case directly to ground through an external path is measured.

### Internal Case Leakage

See Figure 4-3, *Case Internal Leakage*.

1. Plug the EUT (equipment under test) into the test receptacle.
2. Enter menu commands:



3. Select the desired condition:

- **POLARITY**—normal or reversed,
- **NEUTRAL**—open or closed.

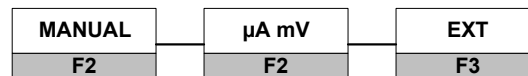
The respective condition LEDs light, and the display reads the current leakage in  $\mu\text{A}$ .

This is a test of leakage current for double insulated devices equipped with a three-conductor power plug. The ground connection is held open. Internal leakage current flows from the equipment under test through its ground wire in the power cord to earth ground.

### External Leakage Current

See Figure 4-4, *External Leakage Current*.

1. Connect the dual banana-plug end of one Kelvin cable to the two **red** external meter posts.
2. Connect the dual banana-plug end of the other Kelvin cable to the two **black** external meter posts.
3. Connect the alligator-clip end of one Kelvin cable to one of the points to be measured.
4. Connect the alligator-clip end of the other Kelvin cable to the other point to be measured.
5. Enter menu commands:



The display reads the current (in  $\mu\text{A}$ ) flow between the two points.

### ECG Lead Leakage

On the front panel of the medTester 5000C, you see ten ECG binding posts. These posts let you measure ECG lead leakage current in the following configurations:

- All leads to ground,
- A single lead to ground,
- Lead to lead,

- Lead isolation, all leads.
- Lead isolation, single lead

**Note**

For all lead-to-ground and lead-to-lead leakage measurements, you can configure the test receptacle with open or closed ground, normal or reverse polarity, and open or closed neutral by toggling GROUND, POLARITY, or NEUTRAL on the display.

**Leakage to Ground—All Leads**

See Figure 4-5, *ECG Lead Leakage to Ground: All Leads to Ground and Individual Lead to Ground*.

1. Plug the EUT into the TEST RECEPTACLE.
2. Connect all ECG leads to their respective binding posts on the medTester 5000C.
3. Enter menu commands:



Displayed measurements are in  $\mu\text{A}$ .

**Leakage to Ground—Individual Lead**

See Figure 4-5, *ECG Lead Leakage to Ground: All Leads to Ground and Individual Lead to Ground*.

1. Plug the EUT into the TEST RECEPTACLE.
2. Connect the ECG lead to be tested to its respective binding post on the medTester 5000c.

Enter menu commands:



Select the desired lead. Lead names are:

RL—right leg,  
RA—right arm,  
LA—left arm,  
LL—left leg, and  
V—V1 through V6 leads tied together. You can measure V leads individually.  
Displayed measurements are in  $\mu A$ .

**Note**

If you receive abnormally high leakage current measurements with V1-V6 leads V together, you can inspect individual V leads by removing the other leads. This procedure allows you to isolate the lead with a high leakage current reading.

**Lead to Lead Leakage**

See Figure 4-6, *ECG Interlead Leakage*.

1. Plug the EUT into the TEST RECEPTACLE.
2. Connect desired ECG leads to their respective binding posts on the medTester 5000C.
3. Enter menu commands:



4. Select the desired lead.

This measures leakage between a selected lead and all other leads tied together.

### Isolation Lead Leakage

See Figure 4-7, *ECG Lead Isolation Test: All Leads and Individual Leads*.

You can do the following two tests in an all-lead or individual-lead mode. The selected lead or leads are connected to the AAMI load with line voltage applied to the lead(s). The test receptacle is fixed with normal polarity, closed ground, and closed neutral during these tests.


#### **WARNING!**

During any isolation lead leakage test, 120 V at 1 mA is present on the ECG leads. This is an electrical shock hazard.

#### **Lead Isolation—All Leads**

1. Plug the EUT into the TEST RECEPTACLE.
2. Connect the ECG leads to be tested to their respective, color-coded binding posts on the medTester 5000C.
3. Enter menu commands:



3. To begin the measurement, press . The test begins, and the ISO VOLTS annunciator lights. The reading is displayed for up to 15 seconds. You can escape to terminate the test. The test self-terminates after 15 seconds.

#### **Lead Isolation—Single Lead**

1. Plug the EUT into the TEST RECEPTACLE.
2. Connect the ECG lead to be tested to its respective color-coded binding post on the medTester 5000C.
3. Enter menu commands:



4. Select the keyboard function key that corresponds to the lead you wish to test.

5. To begin the measurement, press 

ISOV ON
F5

. The test begins, and the ISO VOLTS annunciator lights. The reading is displayed for up to 15 seconds. You can escape to terminate the test. The test self-terminates after 15 seconds.

### Note

If you receive abnormally high leakage current measurements with V1-V6 leads tied together, you can inspect individual V leads by removing the other leads. This procedure allows you to isolate the lead with a high leakage current reading.

## Equipment Current

See Figure 4-8, *Equipment Load Current*.

This test measures current used by the equipment under test. The EUT is plugged into the TEST RECEPTACLE. The receptacle is fixed at normal polarity, closed ground, and closed neutral. The range of this test is 20 amps RMS with an accuracy of  $\pm 5\%$  of the range.

1. Plug the EUT into the TEST RECEPTACLE.
2. Enter menu commands:



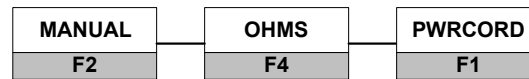
## Resistance

These two resistance tests use the four-terminal test method. Resistance is measured in a range of 2.000  $\Omega$  with an accuracy of  $\pm 1\%$  of range with a test current of 100 mA.

**Power Cord Resistance**

See Figure 4-9, *Power Cord Resistance Test*.

- 1.** Plug the equipment under test into the TEST RECEPTACLE at the top of the medTester 5000C.
- 2.** Connect the dual banana-plug end of a Kelvin cable to the two **red** external meter posts.
- 3.** Connect the alligator-clip end of the Kelvin cable to a grounded point on the case of the equipment under test.
- 4.** Enter menu commands:

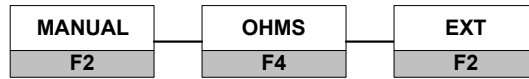


The CURRENT SOURCE lamp lights up to indicate that the connection is made. The display reads the resistance (in OHMS) from the case to the power cord ground pin.

### External Resistance

See Figure 4-10, *External Resistance*.

1. Connect the dual banana-plug end of one Kelvin cable to the two **red** external meter posts.
2. Connect the dual banana-plug end of the other Kelvin cable to the two **black** external meter posts.
3. Connect the alligator-clip ends of the two Kelvin cables to opposite ends of the resistance being measured.
4. Enter menu commands:



The CURRENT SOURCE lamp lights up to indicate that the connection is made. The display reads the resistance (in OHMS).

### Isolated Power and Ground Fault Test

See Figure 4-11, *Isolated Power System and Ground Fault Test*.

This test requires the Fluke Biomedical Model 202A *Isolated Power Test Module* plugged into the test receptacle of the medTester 5000C. The Model 202A introduces faults on isolated power systems and grounded systems.

Refer to Model 202A Operating and Service Manual for details on ground fault and isolated power testing.

Enter menu commands:





### Toolbox

Toolbox consists of measurements that require the use of three adapters. These adapters, available from third-party suppliers, are used to perform the following tests:

- Tachometer—to calculate the speed of rotating devices, such as centrifuges;
- Temperature—to verify hospital environment conditions for temperature; and
- Humidity—to verify hospital environment conditions for humidity.

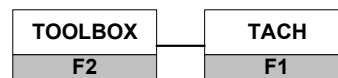
### Tachometer

1. Plug the tachometer adapter test leads into the EXT INPUT jacks on medTester's front panel.

#### Note

Set the range switch to HIGH RANGE (1000-19990 RPM) to interface correctly with medTester.

2. Enter menu commands from MENU 2:



3. Place a piece of reflective tape on the rotating surface of the EUT. The tachometer light beam shines on the tape.
4. Power on the EUT. Point the tachometer at the reflective tape. Press and hold the **Adapter Activate** button on the adapter. The medTester displays the tachometer measurements. You can reset the maximum level to the current speed level displayed on the top line by pressing the **RESET (F1)** key.

### **Temperature**

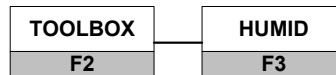
- 1.** Plug the temperature adapter test leads into the EXT INPUT jacks on medTester's front panel.
- 2.** Set the adapter's power switch to the desired temperature scale, Fahrenheit or Celsius. It must match the medTester selection.
- 3.** Enter menu commands from MENU 2:

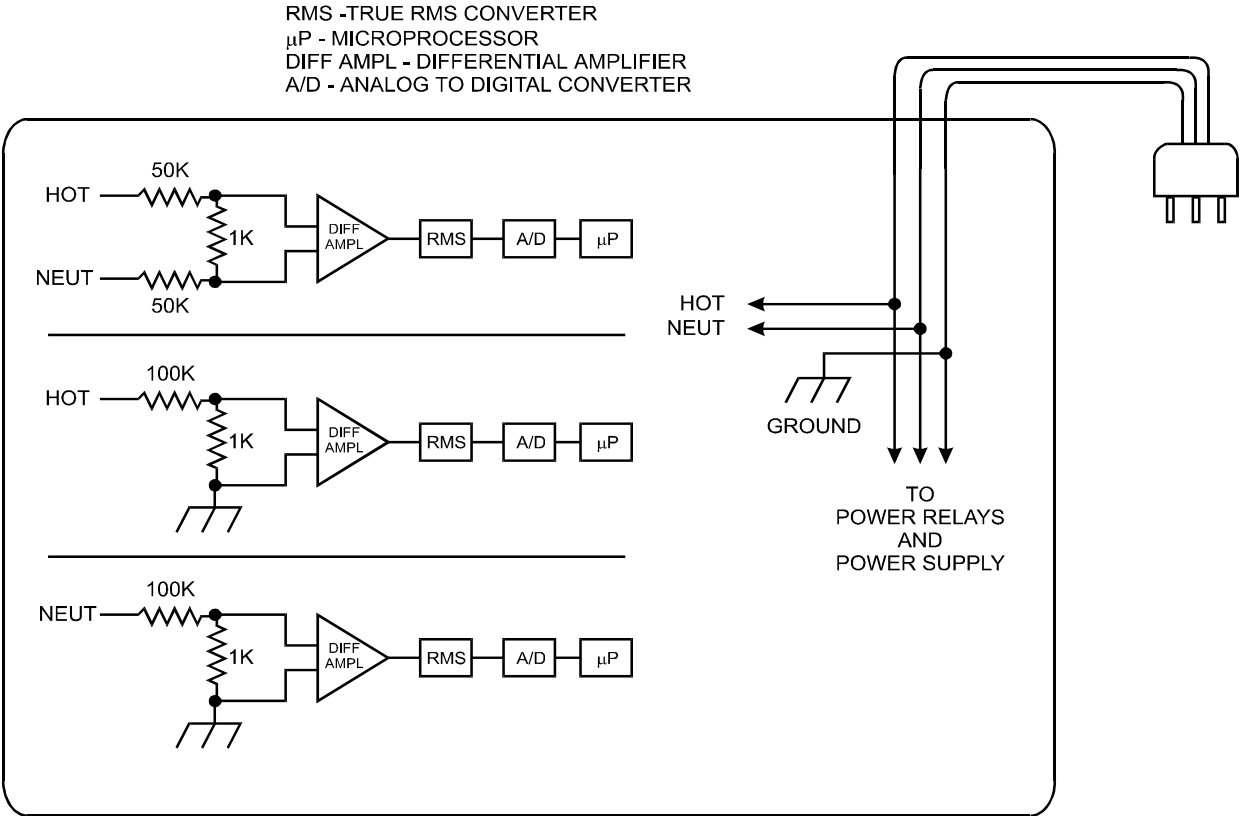


- 4.** Press the °F/°C (F2) key for the desired temperature scale.
- 5.** For resetting the maximum reading to become the minimum, press the RESET (F1) key.

### **Humidity**

- 1.** Plug the humidity adapter test leads into the EXT INPUT jacks on medTester's front panel.
- 2.** Power on the adapter.
- 3.** Enter menu commands from MENU 2:





**Figure 4-1.** Three Types of Line Voltage Measurements

RMS - TRUE RMS CONVERTER  
 $\mu$ P - MICROPROCESSOR  
DIFF AMPL - DIFFERENTIAL AMPLIFIER  
A/D - ANALOG TO DIGITAL CONVERTER

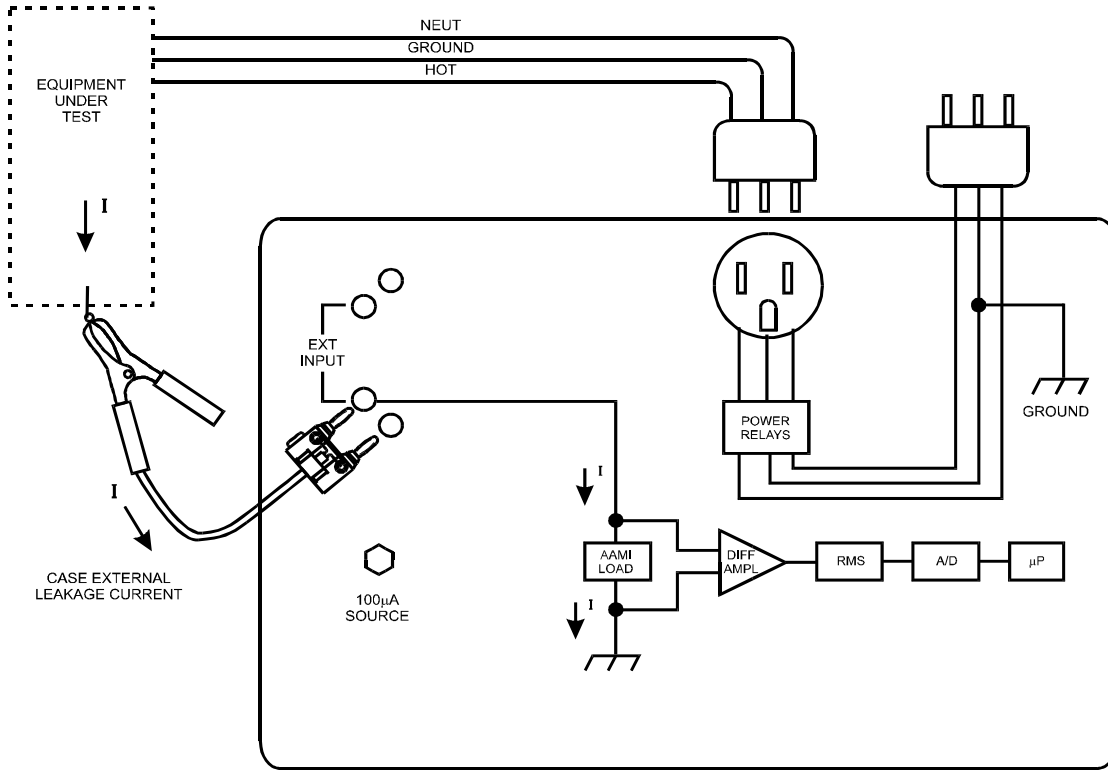
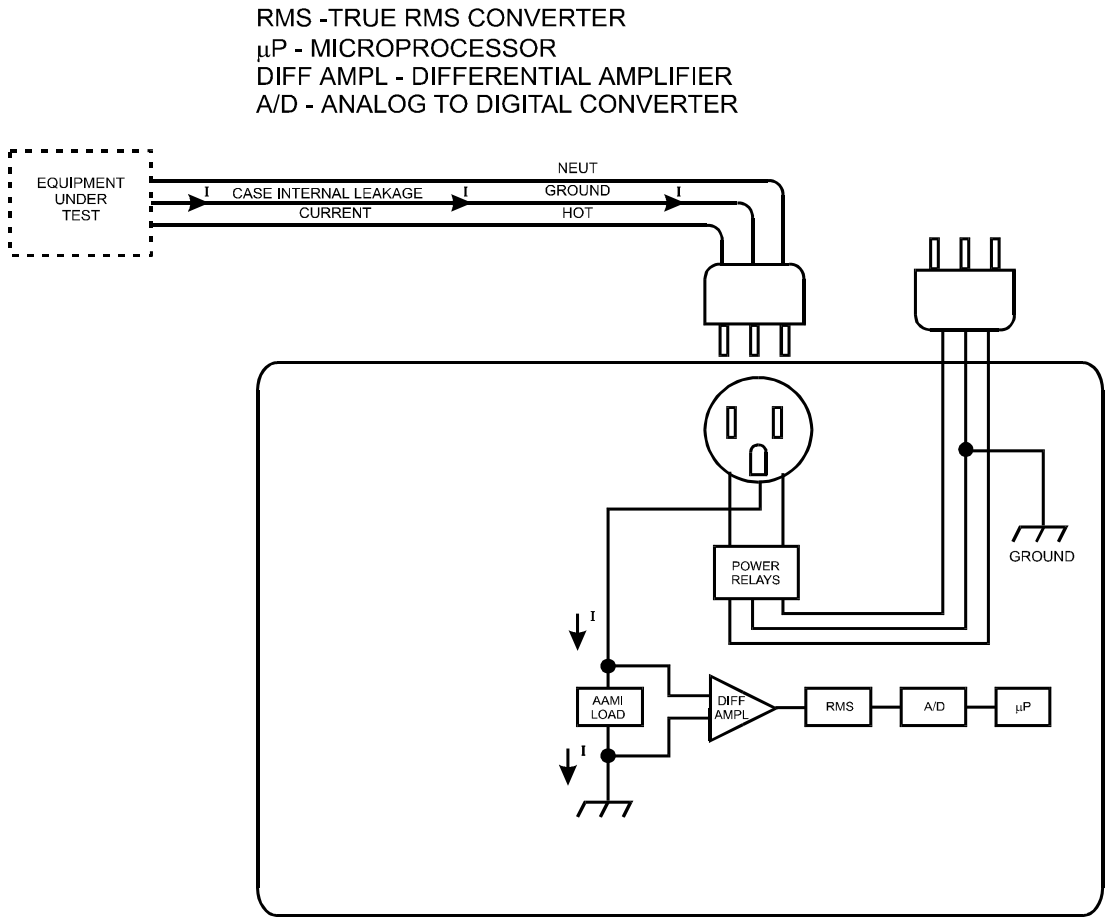
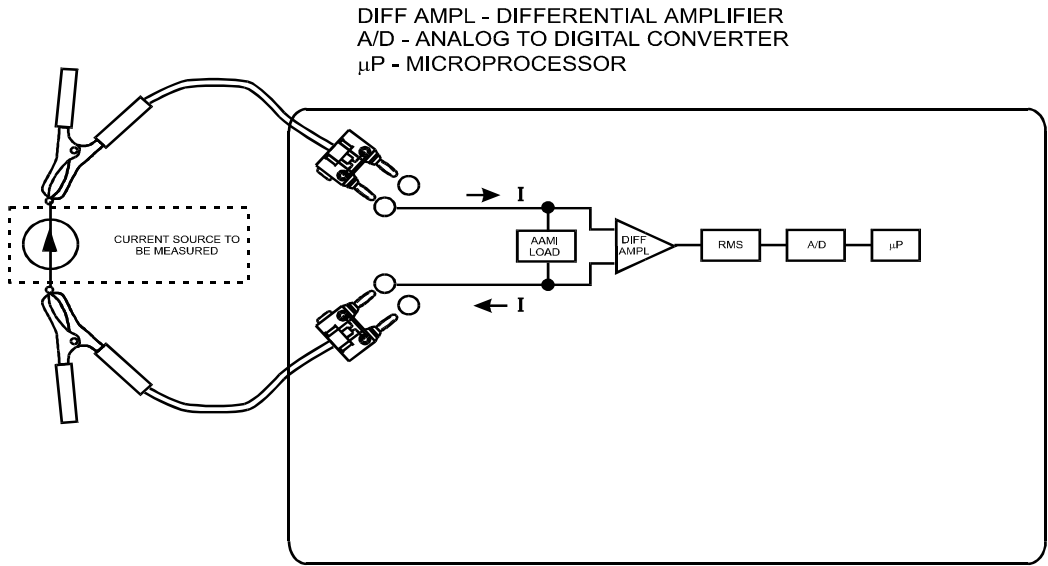


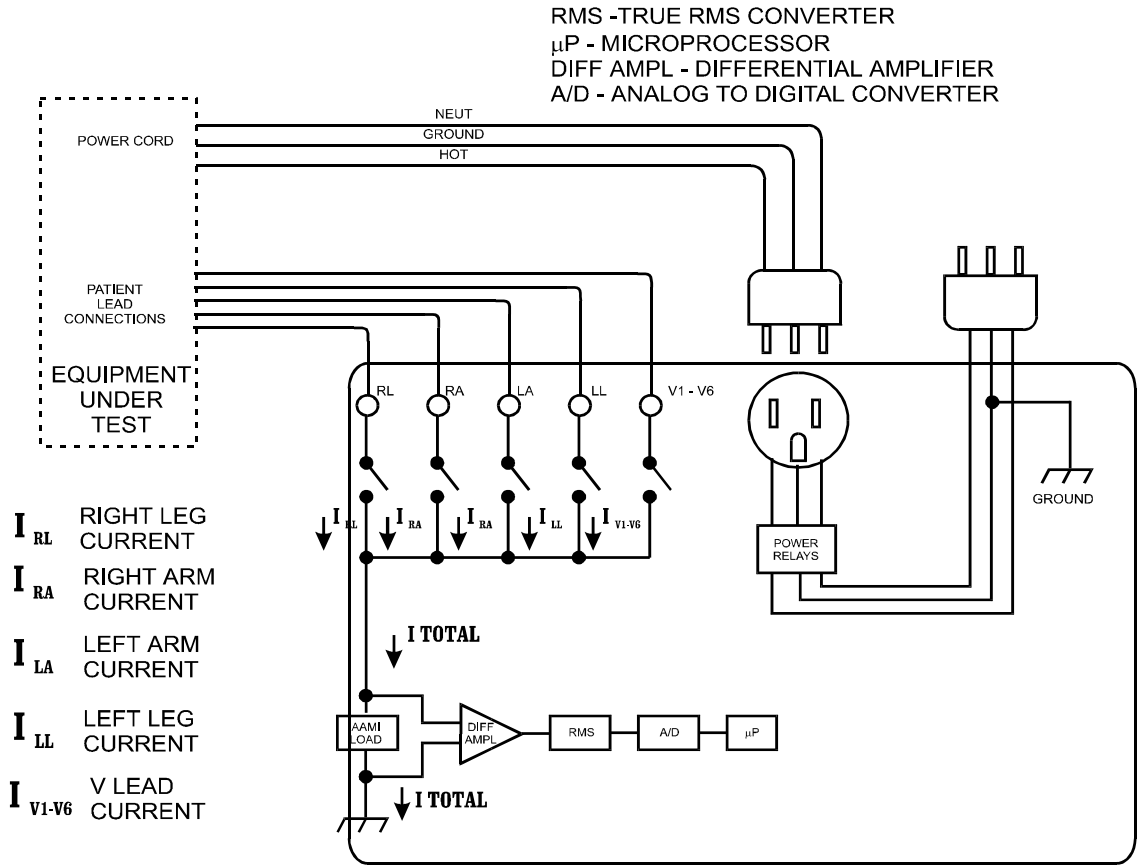
Figure 4-2. Case External Leakage



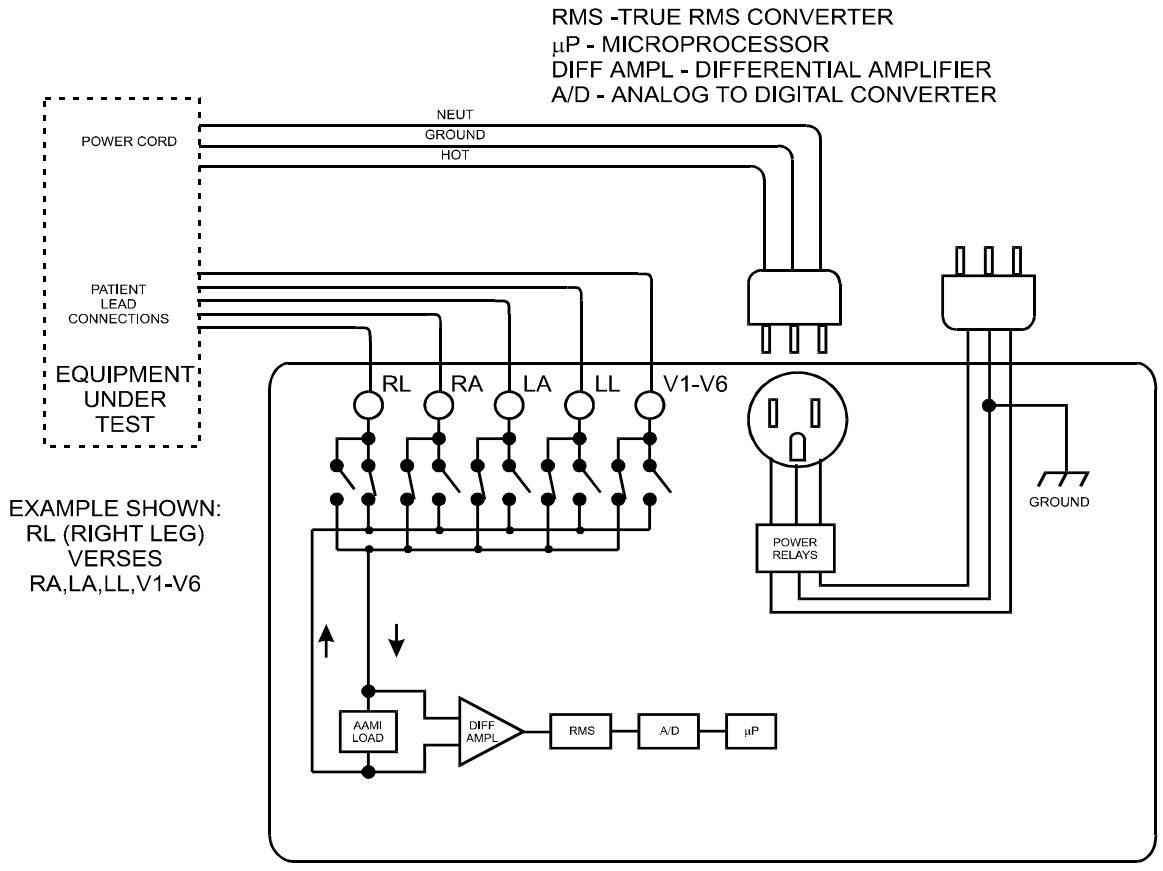
**Figure 4-3.** Case Internal Leakage



**Figure 4-4.** *External Leakage Current*

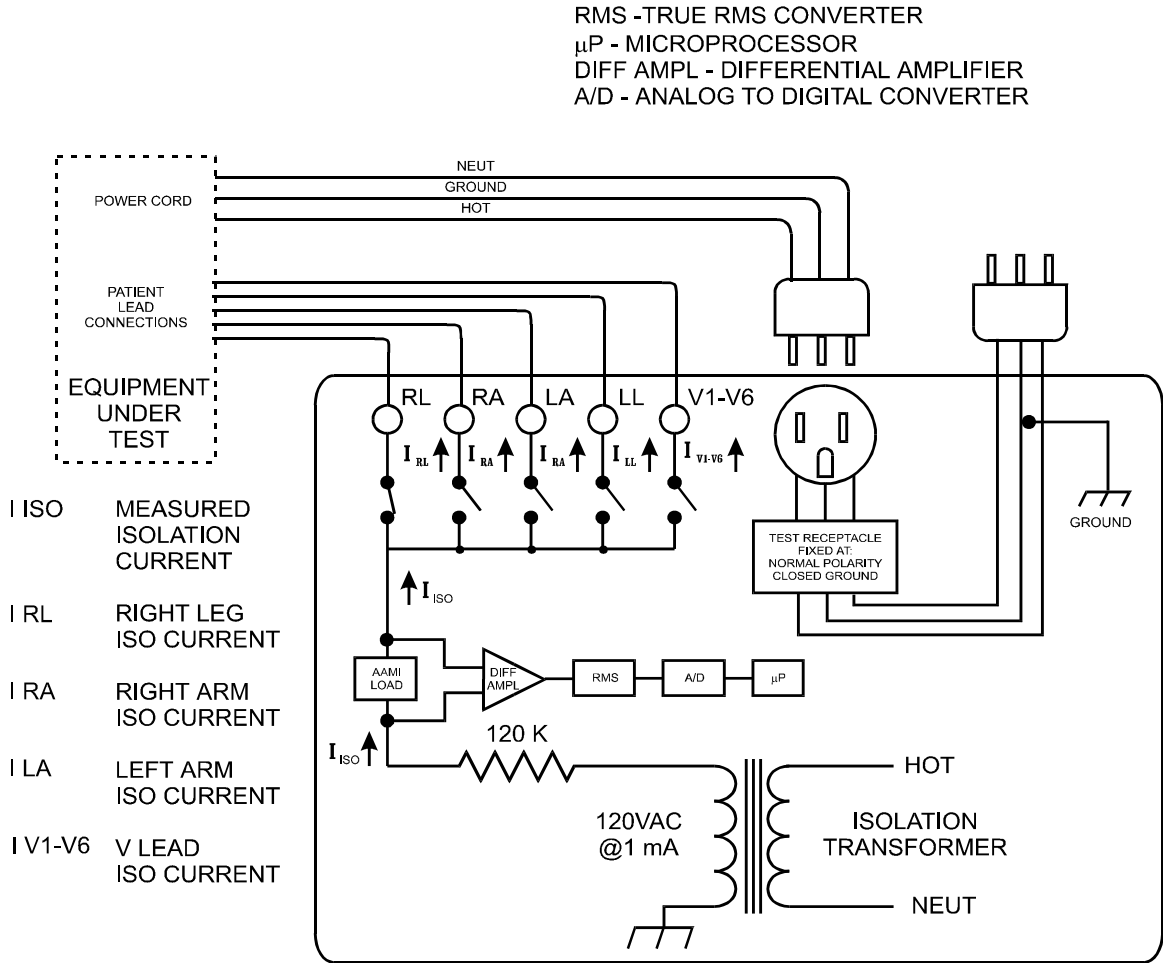


**Figure 4-5.** *ECG Lead Leakage to Ground: All Leads to Ground and Individual Lead to Ground*



**Figure 4-6.** *ECG Interlead Leakage*





**Figure 4-7.** ECG Lead Isolation Test. All Leads and Individual Leads

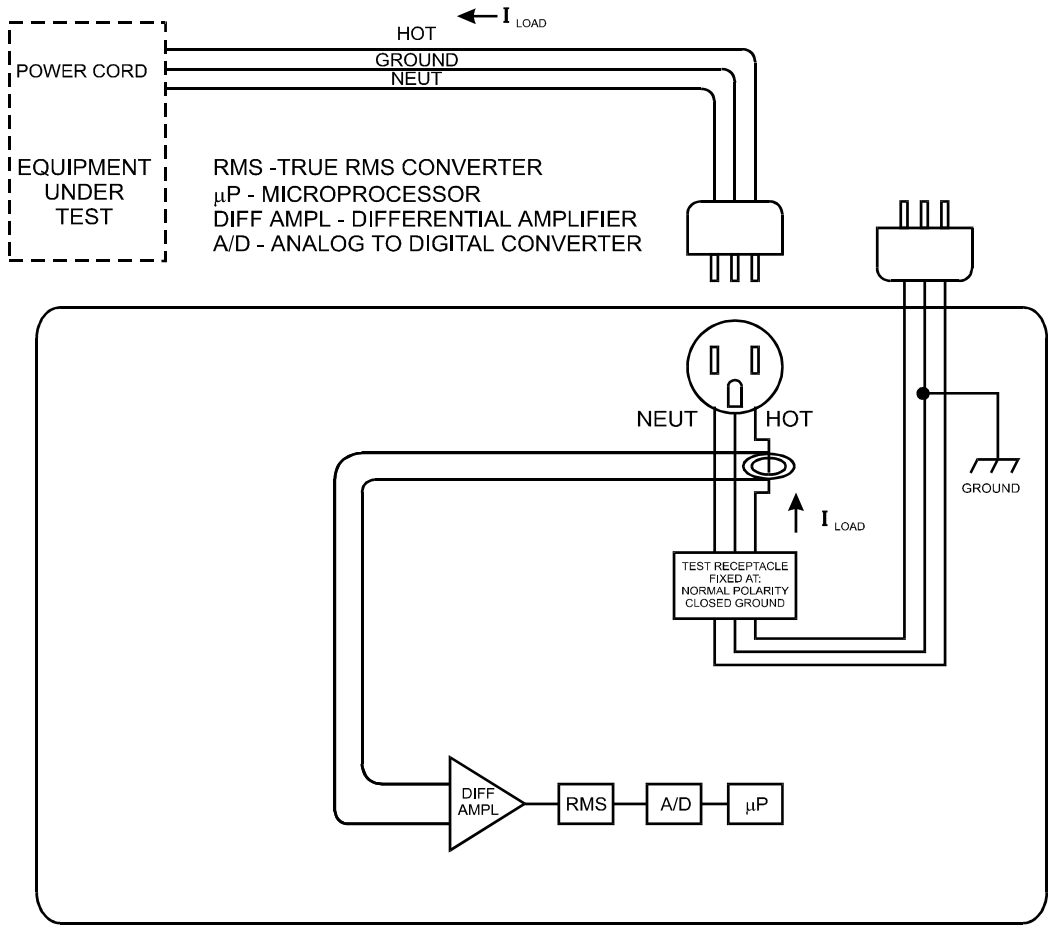
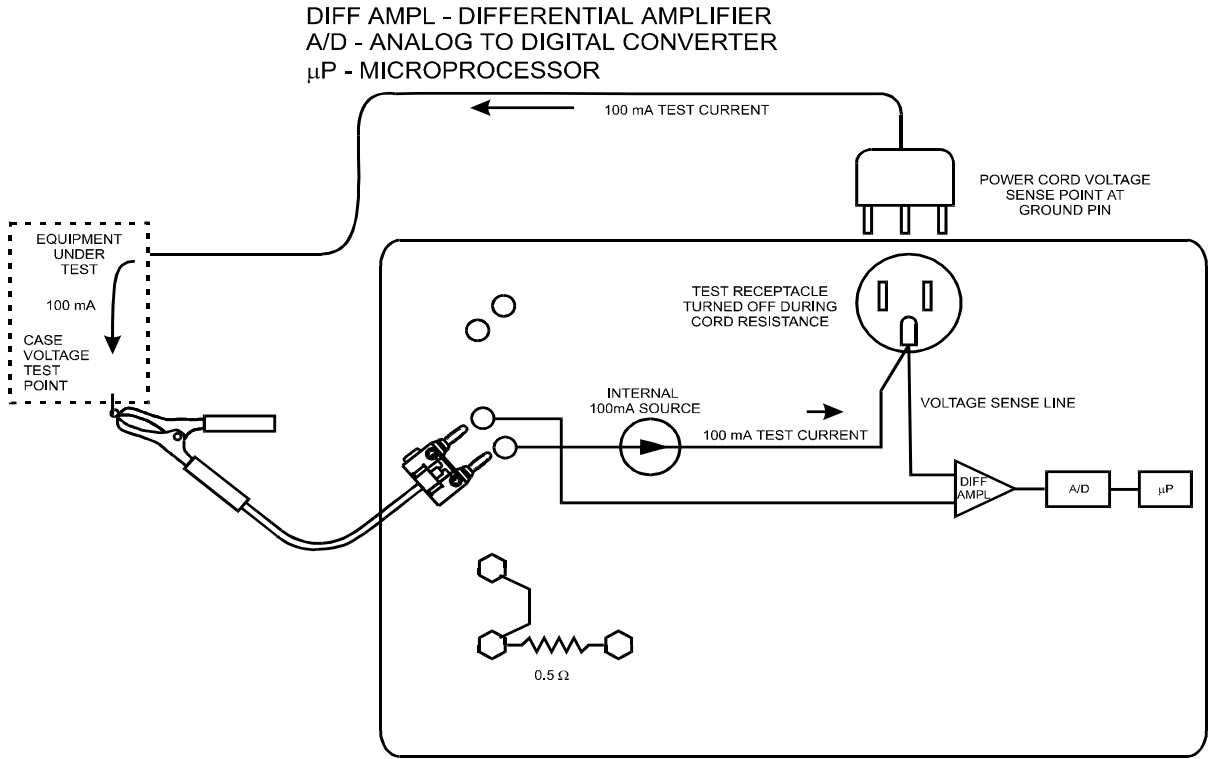
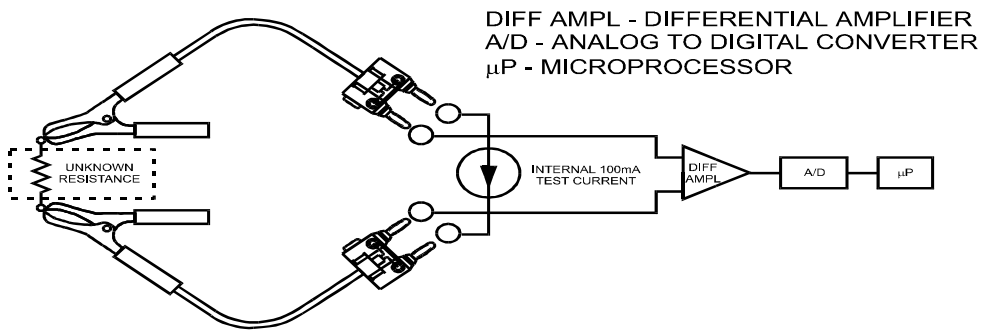


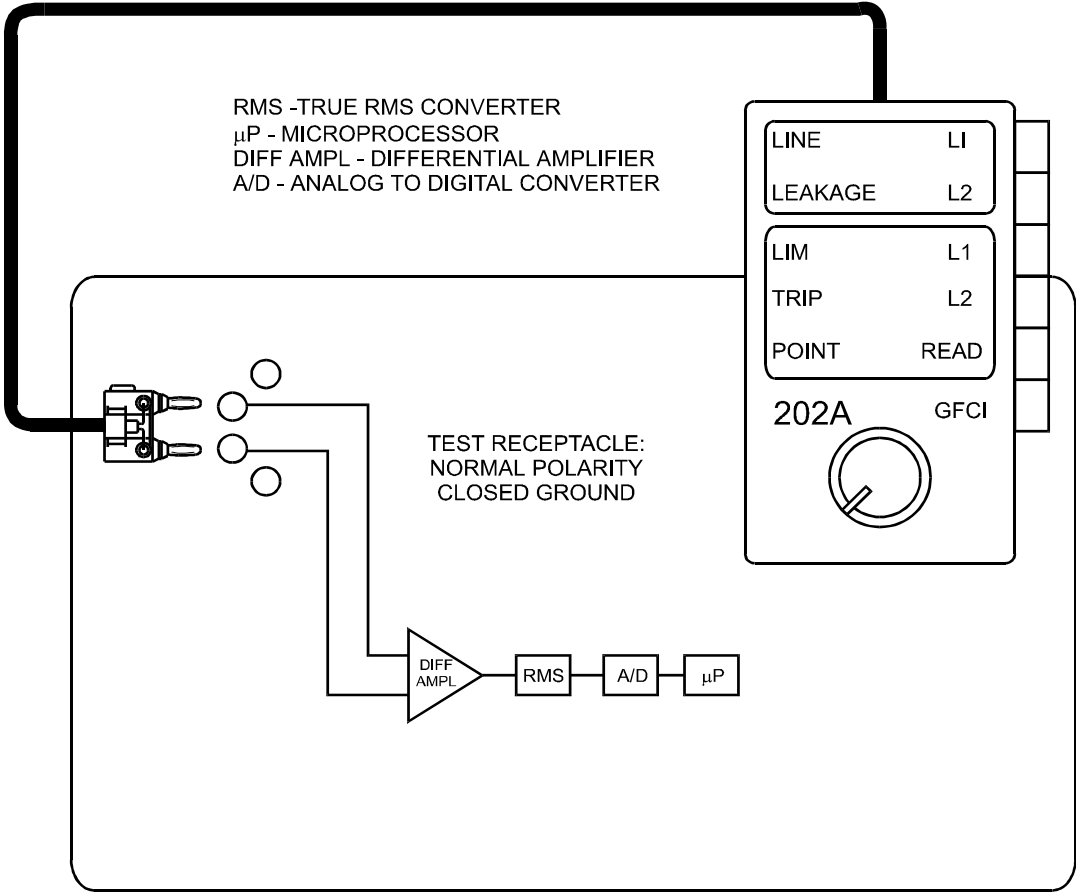
Figure 4-8. Equipment Load Current



**Figure 4-9.** *Power Cord Resistance Test*



**Figure 4-10.** *External Resistance*



**Figure 4-11.** *Isolated Power System and Ground Fault Test*



# Chapter 5

## Autosequences

*This chapter explains how to use the medTester 5000C's electrical safety autosequences, two standard monitoring sequences for temperature and humidity, and two optional monitoring autosequences for line voltage and ground potential.*

### What Is an Autosequence

An autosequence is a preprogrammed test sequence. The medTester 5000C base model includes ten standard electrical safety autosequences and two monitoring autosequences for temperature and humidity. If your medTester 5000C has the Waveform/Extended Testing Module installed, you can also output performance waves for patient monitor testing purposes during safety autosequences. If you do not have the Waveform/Extended Testing Module, you can still perform safety tests on patient monitor leads.

#### Note

The Waveform/Extended Testing Module includes the simulated ECG waveforms and arrhythmias for testing heart monitors, five additional safety autosequences, environmental testing (for measuring ground potential and resistance among ground points), and line monitor (for periodic measurements of line voltage). For more information about simulated ECG waveforms and arrhythmias, see Chapter 7, *Performance Waves*.

You will find instructions for customizing the ten standard electrical safety autosequences and the five blank safety autosequences (available in the Waveform/Extended Testing Module) in Chapter 6, *Customize Your medTester 5000C*.

Optional autosequences are available now for testing the following types of medical equipment with Fluke Biomedical analyzers connected to the COM2 serial port on the medTester 5000C:

- Defibrillators—Using Fluke Biomedical defibrillator analyzers Impulse 3000 and Impulse 4000 (see Chapter 9, *Defibrillator Module*).
- IV Pumps—Using Fluke Biomedical IV pump tester models IDA 4 Plus, the IPT-1 or the IPT MC IV(See Chapter 10, *IV Pump Module*).
- Electrosurgical Units—Using the Fluke Biomedical electrosurgical analyzer Model 454A or Model RF303RS. (See Chapter 14, *ESU module*)
- SPO2—Pulse Oximeter Simulator, using the Fluke Biomedical CardioSat 100, Oxitest, or Index 2XL SPO2 simulator.(See Chapter 15, *SpO2 module*)
- PACER—External Pacemaker Tester, using the Fluke Biomedical Impulse 4000.(See Chapter 16, *Transcutaneous pacemaker (Pacer) module*)
- NIBP—Non-invasive blood pressure units, using the Fluke Biomedical CuffLink.(See Chapter 17, *Non-invasive Blood Pressure (NIBP) module*)

## Description of Standard Safety Autosequences

As programmed the 10 standard safety autosequences give you general safety and ECG lead tests executed in the order listed below:

- 1.** Line Voltage, including
  - Hot to neutral,
  - Neutral to ground,
  - Hot to ground.
- 2.** Power Cord Resistance
- 3.** Leakage Current
  - Internal or external case leakage and ECG lead leakage and isolation, dependent upon autosequence chosen;
  - With EUT power off;
  - With EUT power on.
- 4.** Equipment Current



**Note**

In the standard shipping configuration, tests are performed both with power turned on and with power turned off. You can remove the power off tests by customizing these safety autosequences. See Chapter 6, *Customize Your medTester 5000C*, for details.

**Note**

Detailed descriptions of leakage current tests and how to include them in customized autosequences can be found in Chapter 6, *Customize Your medTester 5000C*.

**Autosequence Selection**

You can select an autosequence by one of these methods:

- medTester 5000C Menu Command—Simply press the function keys for the menu command that leads you to a specific autosequence name. See *Menu Command* in the table that follows for a list of autosequence names and commands.
- Keyboard Shortcuts—Type the desired sequence remote command directly from the keyboard. See *Keyboard Shortcut Command* also in the following table.
- Bar Code Scan Gun—Use the Fluke Biomedical bar code Scan gun or barcode wand, if an older unit and so equipped, to select a keyboard shortcut command.
- COM Ports—Enter the sequence keyboard shortcut command using:
  - The optional Fluke Biomedical keyboard,
  - The optional Fluke Biomedical laser bar code gun,
  - A personal computer.

## Standard Safety Autosequence Names

You can access autosequences from either medTester menu commands or from the keyboard shortcut commands. See the list of autosequences below.

SAFETY AUTOSEQUENCES			
Autosequence Name	Function	Menu Command From medTester 5000C Main Menu (MENU 1)	Keyboard Shortcut Commands
10LD X	10 Lead External Test	AUTO SAFETY 10LDX F1 F1 F1	A1
3LD X	3 Lead External Test	AUTO SAFETY 3LDX F1 F1 F2	A2
4LD X	4 Lead External Test	AUTO SAFETY 4LDX F1 F1 F3	A3
CASE X	Case External Critical Device, No Leads	AUTO SAFETY CASE X F1 F1 F4	A4
GEN X	General Device, No Leads	AUTO SAFETY GEN X F1 F1 F5	A5
From MENU 2			
10LD I	10-Lead Internal Test	AUTO SAFETY 10LD I F1 F1 F1	A6
3 LD I	3-Lead Internal Test	AUTO SAFETY 3LDI F1 F1 F2	A7
4 LD I	4-Lead Internal Test	AUTO SAFETY 4LDI F1 F1 F3	A8
CASE I	Case Internal Critical Device, No Leads	AUTO SAFETY CASE I F1 F1 F4	A9
GEN I	General Device Internal, No Leads	AUTO SAFETY GEN I F1 F1 F5	A10
From MENU 3			
blank	User-defined	AUTO SAFETY blank F1 F1 F1-F5	A11-A15
From medTester 5000C Main Menu			
LINEMON	Line Voltage Monitor	AUTO → LINEMON F1 F4	A16
ENVMON	Environment Monitor	AUTO → ENVMON F1 F5	A17

SAFETY AUTOSEQUENCES							
TEMPMON	Temperature Monitor	<table border="1" style="margin: auto;"> <tr> <td style="text-align: center;">TOOLBOX</td> <td style="text-align: center;">TEMPMON</td> </tr> <tr> <td style="text-align: center;">F2</td> <td style="text-align: center;">F4</td> </tr> </table>	TOOLBOX	TEMPMON	F2	F4	A18
TOOLBOX	TEMPMON						
F2	F4						
HUMMON	Humidity Monitor	<table border="1" style="margin: auto;"> <tr> <td style="text-align: center;">TOOLBOX</td> <td style="text-align: center;">HUMMON</td> </tr> <tr> <td style="text-align: center;">F2</td> <td style="text-align: center;">F5</td> </tr> </table>	TOOLBOX	HUMMON	F2	F5	A19
TOOLBOX	HUMMON						
F2	F5						

**Autosequence Device Prompts**

After you select an autosequence, medTester prompts you to enter the following information for the device that you want to test. Entry information can be any combination of alpha or numeric characters. After each entry press the ENT (Enter) key.

1. OP CODE—This is the operating code for the person doing the testing. This code can consist of a maximum of three characters which can be entered from the medTester keyboard. An example of an operator code could be a person's initials or employee number. The previous operator's code, if any, will appear. If the current operator has not changed from previous use, press the ENT key.
2. TYPE—Enter the device name, code, or other descriptor for the equipment under test. This entry can be a maximum of 16 characters.
3. MANF—Enter the name of the device manufacturer, 16 characters maximum.
4. LOC—Type in the location of the device, 16 characters maximum. The previous location, if any, will appear. If this occurs and is the desired location, press the ENT key.
5. MODEL—Enter the device model number, 16 characters maximum.
6. SERIAL #—Type the device serial number, again 16 characters maximum.
7. CONTROL #—Enter a control number with a maximum of 16 characters.
8. PHYSICAL INSPECTION—You have two physical inspection lines, each of which can consist of a maximum of 40 characters. After entering data for the first prompt, the second prompt appears.

### Note

All these pre-test prompts can be turned off. However, if using the medTester with an Equipment Management System, at a minimum you will want to leave the Control Number on for the proper work order closure.

### Important Special Character Rules

Remember these rules when typing characters:

- The double quote (“) and tilde (~) characters are illegal and are never accepted from any source including an external keyboard, serial port, or bar code. The medTester 5000C ignores these characters.
- Commas (,) and pound signs (#) are illegal in the CONTROL # and will be rejected with an error message if entered.
- The pound sign (#) is used by the medTester 5000C to flag a failed test and therefore, fail the entire test record. You can also deliberately fail a test record by typing a pound sign (#) in one of these fields:
  - Physical Inspection
  - Comments
  - Performance Comments

Other fields can accept a pound sign (#) without failing the test record.

### Turning Prompts Off

You can turn individual prompts on or off and rename prompts six through eight (6-8) from the list above. See the section *Customizing Your Autosequence Prompts* in Chapter 6. While you may have some or all prompts turned off, the autosequence still gives you the opportunity to enter device information with the message:

Press F5 for all device info prompts

This message appears on the display for two (2) seconds. If you press F5 within the two-second period, prompts two (2) through seven (7) show. This procedure only affects the current execution of the autosequence.

The prompt override feature allows you to conveniently enter device information for a new piece of equipment into your equipment management database system.

When prompts are turned off, the medTester 5000C automatically begins the autosequence.

## Autosequence Steps

If you have autosequence prompts turned on, you enter the appropriate information. After responding to prompts, you see this message appear on the medTester 5000C display:

PLUG IN EUT, ATTACH KELVIN CABLE AND  
PATIENT LEADS

This message is telling you to:

1. Plug the EUT into the test receptacle.
2. Attach a single Kelvin cable to the pair of **red** binding posts on the patient lead panel.
3. Attach the Kelvin cable clamp to an exposed grounded surface on the EUT.
4. If the autosequence involves leads, attach the leads to the top-panel, color-coded ECG binding posts.

5. Press 

READY
F5

 after the connections are made. The sequence tests begin. Descriptions of tests follow.

### Note

You can choose which tests your autosequences execute. However, the factory default settings for all autosequences include all of the tests described here. Chapter 6, *Customize Your medTester 5000C*, shows you how to customize autosequence tests.

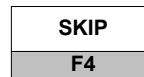
## System Line Voltage

Measurements included are:

- Hot to neutral,
- Neutral to ground, and
- Hot to ground.

## Power Cord Resistance

After taking measurements of line voltage, the autosequence moves to the power cord resistance measurement. The medTester offers you the option of skipping the test. You could skip a resistance measurement, for example, with double-insulated equipment having no exposed metal surfaces. If you choose to skip this test, it is recorded as being skipped. To skip the measurement, from the menu select:



You can proceed with the resistance test, but first notice the displayed reading and CURRENT SOURCE annunciator. If any of the following appear on the medTester display, it means a condition exists that prohibits an accurate measurement:

- # (pound) sign—Indicates an out-of-limit condition based upon the resistance limit set for the autosequence you are running. Limits are programmable.
- x.xxx—Indicates that a current source is not connected.
- Flashing reading—Indicates that the displayed reading is out of range, that is >2 ohms.
- CURRENT SOURCE annunciator not lit—Indicates lack of a good connection.

Correct the cause of the condition before continuing. For example, reconnect the Kelvin cable to an exposed grounded surface on the EUT. If none of these conditions exist and a measurement appears in the display, press:



## Leakage Current Measurements

After the power cord resistance test, the autosequence moves to leakage current measurements with a message:

TURN EUT POWER OFF

### Note

This message appears only if the power-off test prompt is turned on and the power-off tests are enabled. Leakage current tests are always executed with power on and can not be turned off.

The medTester 5000C now executes all leakage current tests in the autosequence—first power-off readings (except where power-off tests are turned off), then power-on readings . To begin the power-off or power-on

READY

F5

tests press when prompted.

The medTester sets the test receptacle to the correct test configuration. A five-second delay occurs whenever the test receptacle switches between normal and reverse polarity. If a # (pound) sign appears, an out-of-limit condition is indicated.

### Note

For a complete list and description of leakage current tests, see Chapter 6, *Customize Your medTester 5000C*.

## Equipment Current Measurement

This test measures the current used by the EUT.

## ECG Performance Waveforms

If you have the Waveform/Extended Testing module installed on your medTester 5000C, and you have performed a lead test, this message appears:

OUTPUT PERFORMANCE WAVES?

This is a prompt to output an autosequence of performance waves to a patient monitor from the patient leads attached to the medTester 5000C. Waveforms are output in the order described in the table below for various periods of time.

Waveform Name	Test Duration (In Seconds)
2 Hz Square	Continuous
4-second Pulse	8
10 Hz Sine	4
40 Hz Sine	4
60 Hz Sine	60
100 Hz Sine	4
1 kHz Square	4
2 Hz Triangle	Continuous
CMRR 60 Hz	Continuous
ECG 60 BPM	Continuous
ECG 30 BPM	30
ECG 60 BPM	30
ECG 120 BPM	30
ECG 240 BPM	30

### Note

Tests with a predefined duration automatically end. However, you can choose to terminate them at any time by pressing NEXT. Those marked *continuous* can be terminated by pressing NEXT.



**Note**

See Chapter 7, *Performance Waves*, for detailed instructions about performance waveform output.

**End-of-Test Prompts**

At the end of the autosequence, the medTester prompts you for the following data. After each entry press the ENT key.

1. **PERFORMANCE WAVE COMMENTS**—This prompt appears only if performance waveforms are output to the EUT.
2. **COMMENTS**—General comments about the autosequence or condition of the EUT. This entry can be a maximum of 40 characters.
3. **NEXT TEST DUE DATE**—For the EUT, ten (10) characters maximum.
4. **USER TIME**—Enter the time used by the user to perform the tests. The format can be six (6) digits, including a decimal point.

**Note**

All these post-test prompts can be turned off. However, if using the medTester with an Equipment Management System, at a minimum you will want to leave User Time on for the proper work order closure.

After entering this data, the medTester computes the elapsed autosequence test time in seconds. Next, if the RS-232/Printer module is installed, the autosequence continues with the test tag print function. If this module is not installed, the autosequence ends.

**Tag Print Function**

With the RS-232/Printer module, the medTester 5000C prompts:

PRINT TEST TAG?

This prompt appears only if you enable the prompt in the CUSTOM menu. See Chapter 6, *Customize Your medTester 5000C*, for information about turning autosequence prompts on and off. If you choose to print a test tag, the following fields print if you have them turned on:

- Header—The current active header (e.g. Hospital or service business name)
- Control #
- Date
- Next test due date
- Op (operator) code

### **Storing An Autosequence Record**

After the autosequence is finished, the medTester prompts you to store the test record to memory and/or to print the record. Record storage is available if you have a Memory Module option installed.

FINISHED, STORE RECORD TO:		
PRINTER	MEMORY	QUIT
F1	F2	F5

#### **Note**

Storing and printing prompts can be turned off for automatic record storage. See *Customizing your Autosequence Prompts* in Chapter 6.

## Test Tag Printer

After performing an autosequence or checklist (test procedure created in your CMMS) with the “Print Test Tag” prompt enabled, the medTester will prompt you to choose whether or not to print a test label. Attaching a Test Tag label to a piece of equipment makes it easy to identify when that piece of equipment was tested, who conducted the test and if desired, when the equipment is due for its next test.

This section describes the setup and operation for printing Test Tags through the medTester 5000C, using an optional Test Label Printer. Either the Brady TLS PC Link (PN 2245515), the Fluke Biomedical Model TLP-1 or TLP-2 label printers are compatible with the medTester 5000C.

The Test Tag printer function will print up to five lines of information. Each line describes a different parameter called a field and can hold up to 23 characters comprised of the field description, the output data itself and any spaces created by the medTester.

### Note

With the TLP-1 & 2, lines longer than the maximum number of allowed characters will *wrap* to the next line on the label. For example, if line number one is longer than 23 characters, remaining characters will print on the second line. Since every other line will print on the line below and if all five lines are used, this will cause the fifth line to print on the next label of the roll. With the TLS printer, each line longer than 23 characters will simply be truncated

You can customize the printout by choosing any or all of the five fields listed in the table below. For example, you could exclude the fourth line (*Due*). You can not include other device or test information on the label.

Test Tag Line Number	Field Description	Maximum Number of Characters in the medTester	Maximum Number of Characters on the Label Line
1:	HEADER: (or facility name)	30	23
2:	CN: (equipment control number)	16	16
3:	DATE: (current date)	8	8 (mm/dd/yy)
4:	DUE: (next test due date)	9	9
5:	OP CODE: (operator code)	3	3

**Note**

To enable or disable any of the five test tag fields (lines), see *Test Tag Configuration* in Chapter 6, *Customize Your medTester 5000C*.

**To set up and connect a label printer:**

1. Attach the provided power supply to the printer and plug it into a three-wire 120V wall outlet or similar receptacle. Optional with the Brady TLS printer with rechargeable batteries.
2. Connect the provided serial cable to the printer.
3. Connect the printer to the desired medTester serial port (COM1 or COM2 unless the Wedge is installed) using the DB-25 connector on the supplied serial cable. See the note below.
4. Turn the printer power on.
5. Load a roll of labels inside the printer. See the supplied instructions with the label printer.

**Note**

After powering up the Brady printer, the first label contains extra space at the front. To avoid a longer first label, press feed, and then cut off the excess label material. All following labels will be the correct length. The Brady TLS printer uses 50' x 1" rolls of continuous vinyl label material. The label material is available in different colors. See the *Optional* parts list in the Accessories section of Chapter 1, *General Information*. The Brady label printer can be used for a variety of other labeling jobs; other types of label materials are available from the Brady distributor. Use the proper ribbon for the type of label material installed. Replace the ribbon when it has been used up.

**Selecting a label printer**

The medTester 5000C defaults to the Fluke Biomedical Model TLP-1 & 2 printer. To select a different printer, use the CUSTOM / TAG menu path.

1. From the menu, press **F1** (CONFIG) as before to configure your test tag (test tag lines on/off), or press **F2** (PRINTER) to select a label printer.
2. From the (PRINTER) menu press **F1** (TLP) to select Fluke Biomedical TLP printers (TLP-1 or TLP-2), or **F2** (BRADY) to select the Brady printer. The selection is displayed.
3. Press **F5** (STORE) to store the selection in nonvolatile EEPROM memory.

**Note**

When using the Brady printer, it is not necessary to set the number of lines on the label with the UTIL / PRTPAGE / TAGS menu path. However, you still need to select the fields you want printed on the label through the CUSTOM/TAG/CONFIG menu path.

To configure a medTester serial port for test tag printing, see *Local Output for Records and Tags* in Chapter 12, *Remote Operation*. To configure one of the Wedge adapter COM2 ports for test tag printing, see *Setting Output Ports* in Chapter 13, *The Wedge Adapter*

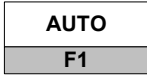
## Optional Monitoring Autosequences

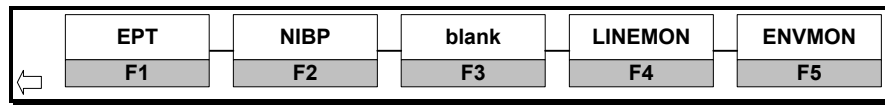
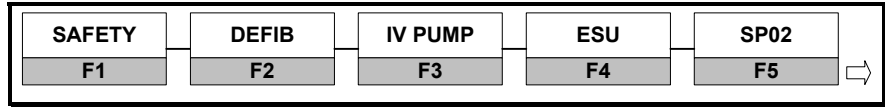
Two optional autosequences are available in the Waveform/Extended Testing Module. Both are designed as monitors.

- Line monitor voltage test—periodically measures line voltage, and
- Environmental test—which measures ground potential and resistance between a common ground point and up to 99 other ground points in a room.

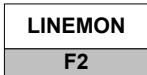
MONITORING AUTOSEQUENCES							
Autosequence Name	Function	Menu Command From MENU 2	Remote Command				
LINEMON	Line voltage monitor.	<table border="1" style="display: inline-table; vertical-align: middle;"> <tr> <td style="text-align: center;">AUTO</td> <td style="text-align: center;">LINEMON</td> </tr> <tr> <td style="text-align: center;">F1</td> <td style="text-align: center;">F4</td> </tr> </table>	AUTO	LINEMON	F1	F4	A16
AUTO	LINEMON						
F1	F4						
ENVMON	Ground potential and resistance.	<table border="1" style="display: inline-table; vertical-align: middle;"> <tr> <td style="text-align: center;">AUTO</td> <td style="text-align: center;">ENVMON</td> </tr> <tr> <td style="text-align: center;">F1</td> <td style="text-align: center;">F5</td> </tr> </table>	AUTO	ENVMON	F1	F5	A17
AUTO	ENVMON						
F1	F5						

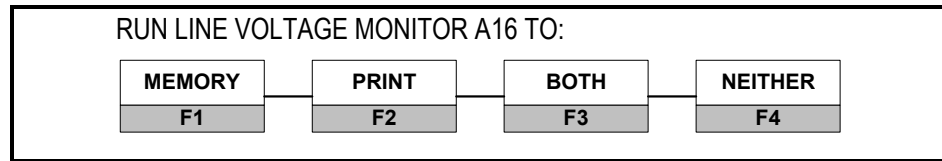
### Menu Selection Procedure

Both monitoring autosequences are found under . Press the right arrow key on the medTester keyboard to access either autosequence.



### Line Voltage Monitor

After you select  from the menu, medTester prompts—

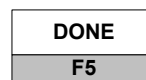


Select **MEMORY** if you want to store the test record. This requires the RS-232/Printer module and the 100 Record Memory module. Select **PRINT** if you want to print the test record. Select **BOTH** if you want to store and print the record.

The medTester will prompt you to enter the following information. Entry information can be any combination of alpha or numeric characters. After each entry press the ENT key.

1. **OP CODE**—The operator is the person doing the testing. This code can consist of a maximum of three characters which can be entered from the medTester keyboard or barcode Scan Gun. An example of an operator code could be a person’s initials or employee number. The previous operator’s code, if any, will appear. If the current operator has not changed from previous use, press the ENT key.
2. **LOC**—Type in the location of the device, 16 characters maximum. The previous location code, if any, will appear. If this occurs and is the desired location, press the ENT key.
3. **CONTROL #**—Enter a control number with a maximum of 16 characters.
4. **CYCLE TEST TIME IN MINUTES**—Enter the time between measurements (1-9 minutes).
5. **TRIGGER LEVEL**—Enter the trigger threshold, that is the amount of deviation in hot-to-neutral voltage that causes an automatic measurement (1-9 volts).

Test measurements of voltage begin and display. Every cycle or trigger measures and records hot-to-neutral voltage, neutral-to-ground voltage, and hot-to-ground voltage measurements. Ctrl+P triggers the readings. When you finish, press:



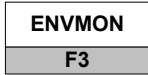
**End-of-Test Prompts**

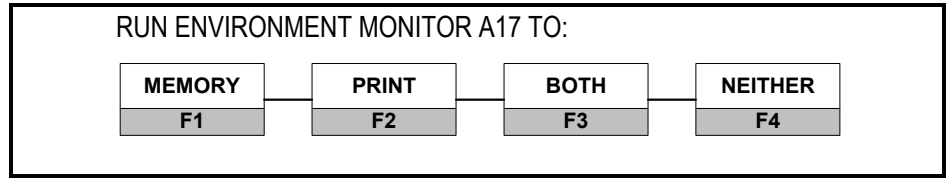
At the end of the autosequence, medTester prompts you for the following data: (prompts can be turned off)

- COMMENTS
- NEXT TEST DUE DATE
- USER TIME
- FINISHED—STORE RECORD? (appears if memory was selected)

**Environmental Monitor**

This test lets you make ground potential and resistance measurements between a common ground point and up to 99 other ground points in a room.

After you select  from the menu, medTester prompts—

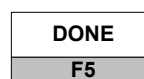


Select **MEMORY** if you want to store the test record. This requires optional Fluke Biomedical memory modules. Select **PRINT** if you want to print the test record. Select **BOTH** if you want to store and print the record.

The medTester will prompt you to enter the following information. Entry information can be any combination of alpha or numeric characters. After each entry press the ENT key:

1. **OP CODE**—The operator is the person doing the testing. This code can consist of a maximum of three characters which can be entered from the medTester keyboard or barcode Scan Gun. An example of an operator code could be a person's initials or employee number. The previous operator's code, if any, will appear. If the current operator has not changed from previous use, press the ENT key.
2. **LOC**—Type in the location of the device, 16 characters maximum. The previous location code, if any, will appear. If this occurs and is the desired location, press the ENT key.
3. **CONTROL#**—Enter a control number with a maximum of 16 characters.
4. **REFERENCE POINT NAME**—Enter the name of the reference point (16 characters maximum).

You are then prompted to attach Kelvin cables to the reference and measured point or points. Connect the Kelvin cables identical to their connections for the external resistance measurement. See **Figure 4-10. External Resistance**. Enter the name of the measured point. Voltage is measured in mV across the AAMI load and resistance between the reference point and the measured point. You can repeat the measurement or record it. Repeat this process for additional measure points. When finished, press:





### End-of-Test Prompts

At the end of the autosequence, medTester prompts you for the following data: (prompts can be turned off)

- COMMENTS
- NEXT TEST DUE DATE
- USER TIME.
- STORE RECORD? (if memory was selected), or PRINT? (if print was selected)

### Toolbox Monitors

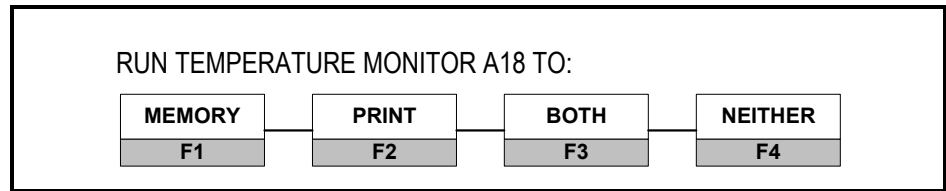
The toolbox menu on the medTester 5000C main menu contains monitoring sequences for temperature and relative humidity. To add these two options to your medTester, contact Extech Instruments Coporation.

### Temperature Monitor

You can monitor temperature readings over periods of time, print the results, and store the results in memory. To access the monitor from the keyboard, enter:



Selections then display as:



Select MEMORY if you want to store the test record. This requires both the RS-232/Printer module and the 100 Record Memory module and . Select PRINT if you want to print the test record. Select BOTH if you want to store and print the record. Follow these set-up instructions:

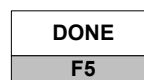
1. Plug the temperature adapter test leads into the EXT INPUT jacks on medTester's front panel.
2. Set the adapter's power switch to the desired temperature scale, Fahrenheit or Celsius. It must match the medTester selection.
3. Press the °F/°C (F2) key for the desired temperature scale.

4. For resetting the maximum reading to become the minimum, press the RESET (F1) key.

The medTester will prompt you to enter the following information. Entry information can be any combination of alpha or numeric characters. After each entry press the ENT key:

1. OP CODE—The operator is the person doing the testing. This code can consist of a maximum of three characters which can be entered from the medTester keyboard. An example of an operator code could be a person's initials or employee number. The previous operator's code, if any, will appear. If the current operator has not changed from previous use, press the ENT key.
2. LOC—Type in the location of the device, 16 characters maximum. The previous location code, if any, will appear. If this occurs and is the desired location, press the ENT key.
3. CONTROL #—Enter a control number with a maximum of 16 characters.
4. CYCLE TEST TIME IN MINUTES—Enter the time between measurements (1-9 minutes).
5. TRIGGER LEVEL—Enter the trigger threshold, that is the amount of deviation in temperature that causes an automatic measurement (1-9 degrees).

Measurements of the temperature begin and display on the top line. Line two of the display indicates the measurement interval and the trigger point temperature. Ctrl-P triggers the readings. To terminate readings, press:



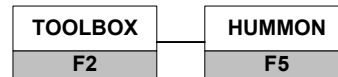
### **End-of-Test Prompts**

At the end of the autosequence, medTester prompts you for the following data: (prompts can be turned off)

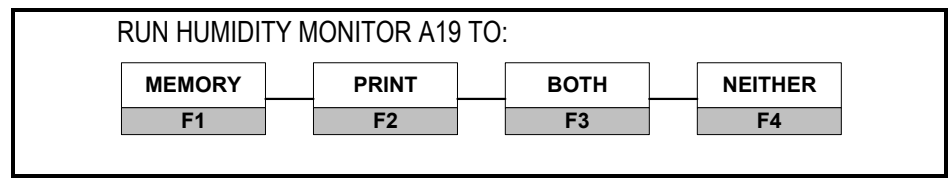
- COMMENTS
- NEXT TEST DUE DATE
- USER TIME
- FINISHED—STORE RECORD? (appears if memory was selected)

## Humidity Monitor

You can monitor the level of relative humidity over periods of time, print the results, and store the results in memory. To access the monitor from the keyboard, enter:



Selections then display as:



Select **MEMORY** if you want to store the test record. This requires both the RS-232/Printer module for printing and the 100 Record Memory module for storage. Select **PRINT** if you want to print the test record. Select **BOTH** if you want to store and print the record. Follow these set-up instructions:

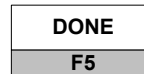
1. Plug the humidity adapter test leads into the **EXT INPUT** jacks on medTester's front panel.
2. Power on the adapter.

The medTester will prompt you to enter the following information. Entry information can be any combination of alpha or numeric characters. After each entry press the **ENT** key:

1. **OP CODE**—The operator is the person doing the testing. This code can consist of a maximum of three characters which can be entered from the medTester keyboard. An example of an operator code could be a person's initials or employee number. The previous operator's code, if any, will appear. If the current operator has not changed from previous use, press the **ENT** key.
2. **LOC**—Type in the location of the device, 16 characters maximum. The previous location code, if any, will appear. If this occurs and is the desired location, press the **ENT** key.
3. **CONTROL #**—Enter a control number with a maximum of 16 characters.

4. CYCLE TEST TIME IN MINUTES—Enter the time between measurements (1-9 minutes).
5. TRIGGER LEVEL—Enter the trigger threshold, that is the percent of deviation in relative humidity that causes an automatic measurement (1-9 percent).

Measurements of the relative humidity begin and display on the top line. Line two of the display indicates the measurement interval and the trigger point percentage. Ctrl+P triggers the readings. To terminate readings, press:



**End-of-Test Prompts**

At the end of the autosequence, medTester prompts you for the following data: (prompts can be turned off)

- COMMENTS
- NEXT TEST DUE DATE
- USER TIME
- FINISHED—STORE RECORD? (appears if memory was selected)

# Chapter 6

## Customize Your medTester

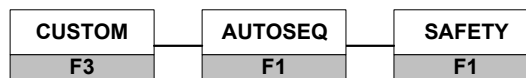
*In this chapter you learn how to customize safety autosequences and how to customize the prompt information that appears before, during, and after the tests execute.*

You can customize the ten standard preprogrammed autosequences and the five blank safety autosequences. (The five blanks are available for use only with the medTester 5000C, Waveform/Extended Testing Module.) Refer to Chapter 5, *Autosequences*, and the table of safety autosequences. From the table you see the list of autosequence names and corresponding remote numbers. For example, the autosequence *10LD X* is called *10 Lead External Test* with a remote number of A1. We begin this chapter by customizing A1.

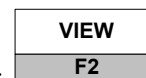
### How to Customize a Preprogrammed Safety Autosequence

To begin learning how to customize safety autosequence A1, *10LD X*, view the steps in the sequence as they exist in the default medTester setup:

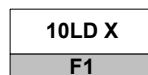
1. From the main menu, MENU1, press the right arrow to access MENU2.
2. Enter the menu commands:



3. From the SAFETY menu, select:



4. Now select the safety autosequence you want to view which is:



5. After pressing this function key, you can begin scrolling through the steps in the sequence by using your up and down arrow keys. Continue viewing our example sequence below.

### **What You See in an Autosequence**

As you scroll through autosequence A1, you see the following:

1 CASE EXT, NORM POL, CLSD GND, CLSD NEU
2 CASE EXT, NORM POL, OPEN GND, CLSD NEU
13 ALL -GND, NORM POL, CLSD GND, CLSD NEU
14 RL -GND, NORM POL, CLSD GND, CLSD NEU

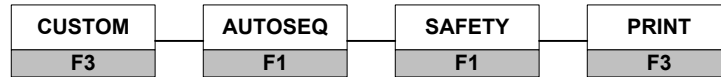
The steps we are viewing are the leakage current tests. This list is not complete; view the entire autosequence for the remaining ones. There are 62 different leakage current tests in the medTester 5000C. Note that autosequence A1 (10LD X) does not contain all 62 tests. You can see all tests listed in the table *Leakage Current Tests* found later in this chapter.

In addition to viewing the leakage current tests in this autosequence, you see a statement about line voltage tests and the four test limits programmed into this autosequence. Since autosequence configurations may differ from one autosequence to another, you could view statements for power-off measurements and single-step.

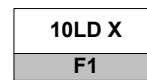
You can press **Esc** to move out of view and back to the previous menu choices, or you can print the autosequence. If you have the medTester 5000C RS-232/Printer module installed with a printer connected to your medTester, do the following to print this autosequence:

1. From the main menu, MENU1, press the right arrow to access MENU2.

2. Enter the menu commands:



3. From the PRINT menu, select:



As your autosequence prints out, compare the sequence to what you viewed to confirm that the two are identical.

Now you can build upon this knowledge, by customizing A1.

### How to Customize

When you customize a safety autosequence, the medTester 5000C prompts you for information you may or may not want to appear in the sequence when it runs. We can see all of these prompts as we begin to customize autosequence A1.

#### Customizing A1

1. From select



2. Press to select safety autosequence 10LD X, the sequence we're customizing. Remember, this has a remote command of A1.

#### Note

Return to factory default setting by either re-initializing (see the *Initialization* section in Chapter 2) or reset Autosequences (see the *Resetting Autosequences to Default Settings* last in this chapter).

### Customizing Menu Steps

As you step through the customizing menu, the medTester asks you to enter information.

#### Note

There are prompts that appear before, during, and at the end of the autosequence. For information about these prompts and how to customize them too, see *Customizing Autosequence Prompts*, at the end of this chapter.

CUSTOMIZING STEPS	
1	Name—name your autosequence.
2	Reverse polarity tests—yes or no. (Saying <i>no</i> means that these tests will not appear in the list of available tests.)
3	Open neutral tests—yes or no. (Saying <i>no</i> means that these tests will not appear in the list of available tests.)
4	Leakage current tests—you receive a prompt for each of the 62 tests. Keep or remove each of them as desired.
5	Line voltage tests—keep or remove.
6	Power off tests—keep or remove.
7	Single step autosequence—if you respond REMOVE, you're saying you do not want to press ENT at the beginning of each step of the autosequence leakage current tests. If you respond KEEP, you're saying you want to press ENT at the beginning of each step of these leakage current tests.
8	Case resistance—enter the limit you want.
9	Case leakage limit—enter the limit.
10	Lead leakage limit—again, enter a limit.
11	Isolation leakage limit—same as above.
12	Store—this is the last step. You are prompted to store your customized autosequence.

Congratulations! You have just customized your first autosequence.

#### Note

The limits you enter for items 8, 9, 10, and 11 above are the limits that the medTester 5000C measures against during the sequence. Measurement readings for these items are compared to the limits you input. If the test result is outside the limits, the test will fail and a # sign is appended to the test record. During an autosequence, the medTester prompts you to repeat a test that fails.



<b>LEAKAGE CURRENT TESTS</b>	
<b>Test Item Legend</b>	
rev—reverse pol—polarity clsd—closed gnd—ground neu—neutral	iso—isolated norm—normal lds—leads All—all leads RL—right leg
RA—right arm LA—left arm LL—left leg V1/6—vector 1-6	
1	Case External, norm pol, clsd gnd, clsd neu
2	Case External, norm pol, open gnd, clsd neu
3	Case External, rev pol, clsd gnd, clsd neu
4	Case External, rev pol, open gnd, clsd neu
5	Case External, norm pol, clsd gnd, open neu
6	Case External, norm pol, open gnd, open neu
7	Case External, rev pol, clsd gnd, open neu
8	Case External, rev pol, open gnd, open neu
9	Case Internal, norm pol, open gnd, clsd neu
10	Case Internal, rev pol, open gnd, clsd neu
11	Case Internal, norm pol, open gnd, open neu
12	Case Internal, rev pol, open gnd, open neu
13	All—gnd, norm pol, clsd gnd, clsd neu
14	RL—gnd, norm pol, clsd gnd, clsd neu
15	RA—gnd, norm pol, clsd gnd, clsd neu
16	LA—gnd, norm pol, clsd gnd, clsd neu
17	LL—gnd, norm pol, clsd gnd, clsd neu
18	V1/6—gnd, norm pol, clsd gnd, clsd neu
19	All—gnd, norm pol, open gnd, clsd neu
20	RL—gnd, norm pol, open gnd, clsd neu
21	RA—gnd, norm pol, open gnd, clsd neu
22	LA—gnd, norm pol, open gnd, clsd neu
23	LL—gnd, norm pol, open gnd, clsd neu
24	V1/6—gnd, norm pol, open gnd, clsd neu
25	All—gnd, rev pol, clsd gnd, clsd neu
26	RL—gnd, rev pol, clsd gnd, clsd neu
27	RA—gnd, rev pol, clsd gnd, clsd neu
28	LA—gnd, rev pol, clsd gnd, clsd neu
29	LL—gnd, rev pol, clsd gnd, clsd neu
30	V1/6—gnd, rev pol, clsd gnd, clsd neu
31	All—gnd, rev pol, open gnd, clsd neu
32	RL—gnd, rev pol, open gnd, clsd neu
33	RA—gnd, rev pol, open gnd, clsd neu

<b>LEAKAGE CURRENT TESTS</b>		
<b>Test Item Legend</b>		
rev—reverse	iso—isolated	RA—right arm
pol—polarity	norm—normal	LA—left arm
clsd—closed	lds—leads	LL—left leg
gnd—ground	All—all leads	V1/6—vector 1-6
neu—neutral	RL—right leg	
34	LA—gnd, rev pol, open gnd, clsd neu	
35	LL—gnd, rev pol, open gnd, clsd neu	
36	V1/6—gnd, rev pol, open gnd, clsd neu	
37	RL—lds, norm pol, clsd gnd, clsd neu	
38	RA—lds, norm pol, clsd gnd, clsd neu	
39	LA—lds, norm pol, clsd gnd, clsd neu	
40	LL—lds, norm pol, clsd gnd, clsd neu	
41	V1/6—lds, norm pol, clsd gnd, clsd neu	
42	RL—lds, norm pol, open gnd, clsd neu	
43	RA—lds, norm pol, open gnd, clsd neu	
44	LA—lds, norm pol, open gnd, clsd neu	
45	LL—lds, norm pol, open gnd, clsd neu	
46	V1/6—lds, norm pol, open gnd, clsd neu	
47	RL—lds, rev pol, clsd gnd, clsd neu	
48	RA—lds, rev pol, clsd gnd, clsd neu	
49	LA—lds, rev pol, clsd gnd, clsd neu	
50	LL—lds, rev pol, clsd gnd, clsd neu	
51	V1/6—lds, rev pol, clsd gnd, clsd neu	
52	RL—lds, rev pol, open gnd, clsd neu	
53	RA—lds, rev pol, open gnd, clsd neu	
54	LA—lds, rev pol, open gnd, clsd neu	
55	LL—lds, rev pol, open gnd, clsd neu	
56	V1/6—lds, rev pol, open gnd, clsd neu	
57	All—iso, norm pol, clsd gnd, clsd neu	
58	RL—iso, norm pol, clsd gnd, clsd neu	
59	RA—iso, norm pol, clsd gnd, clsd neu	
60	LA—iso, norm pol, clsd gnd, clsd neu	
61	LL—iso, norm pol, clsd gnd, clsd neu	
62	V1/6—iso, norm pol, clsd gnd, clsd neu	

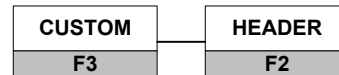
## Customizing a Blank Safety Autosequence

If your medTester 5000C contains the Waveform/Extended Testing Module option (5), you have autosequences A11-A15. On your autosequence menu these are listed as **blank**. You can customize each of these in the same manner as described in *How to Customize* above.

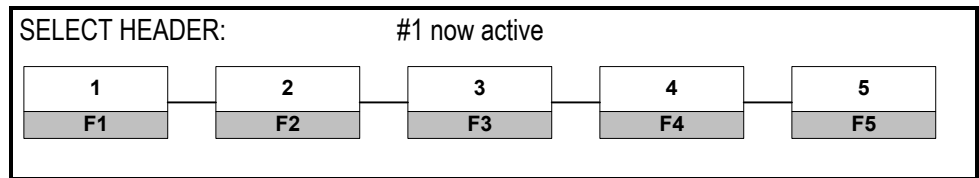
### Test Record Header

You can associate a header with the test record. You can store as many as five headers, one of which you designate as the active header. Typically the header is used to store the hospital name. The header appears on the test record you upload to your data management software program. It also appears on the printed test record or on a printed test tag. Customize a header by doing this:

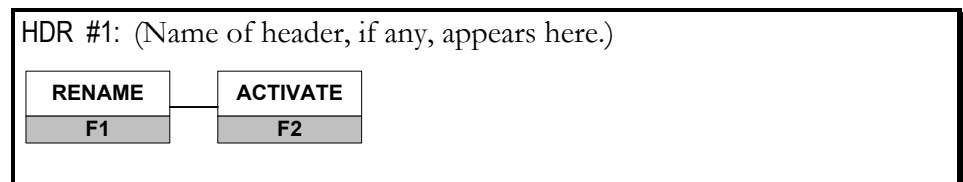
1. From menu 2, select



The following displays on the medTester 5000C (with the corresponding function keys):



2. Press the function key for the header number you are choosing. For example, choose header number one (F1) to see:



3. Press F1 to rename header number one and enter the name of your header. Or press F2 to make header number one the active header.

## Customizing Your Autosequence Prompts

In an autosequence, the medTester 5000C prompts you for information that is included on the test record, which you can print and/or store in memory. Prompts appear before, during, and after the autosequence executes. There are 17 of these prompts in all. Four prompts can be renamed. See the table of prompts below.

medTester Autosequence Prompts		
Prompt #	Prompt Name/ Renameable? (Yes or No)	Description
<b>Pretest Prompts</b>		
1	OP CODE (No)	The operator code for the person doing the testing. Maximum of three characters .
2	TYPE (No)	The type of device, or other descriptor for the equipment under test. Maximum of 16 characters.
3	MANF (No)	Enter the name of the device manufacturer, 16 characters maximum.
4	LOC (No)	Type in the location of the device, 16 characters maximum.
5	MODEL (No)	Enter the device model number, 16 characters maximum.
6	SERIAL # (Yes)	Type the device serial number, again 16 characters maximum.
7	CONTROL # (Yes)	Enter a control number with a maximum of 16 characters.
8	PHYSICAL INSPECTION (Yes)	You have two physical inspection lines, each of which can consist of a maximum of 40 characters. After entering data for the first prompt, the second prompt appears.
<b>Prompts During Tests</b>		
9	PLUG IN EUT MESSAGE (No)	This turns on or off the message: <i>PLUG THE EUT INTO THE MEDTESTER TEST RECEPTACLE, ATTACH A KELVIN CABLE AND ANY PATIENT LEADS TO BE TESTED.</i>
10	TURN EUT POWER OFF MESSAGE (No)	This message prompts the user to turn the power off on the EUT. This prompt is active only if the power-off tests are to be performed.
11	TURN EUT POWER ON MESSAGE (No)	Turn EUT power on.
<b>Prompts After Tests</b>		
12	PERFORMANCE WAVE COMMENTS (No)	Enter comments about the performance wave tests. The prompt is active only in a safety autosequence in which performance waves were generated. Maximum of 40 characters.
13	COMMENTS (Yes)	Enter general comments. Enter 40 characters maximum.

medTester Autosequence Prompts		
Prompt #	Prompt Name/ Renameable? (Yes or No)	Description
14	NEXT TEST DUE DATE (No)	Enter the next test due date. Maximum of nine characters.
15	USER TIME (No)	Enter the time used by the user to perform the tests in hours. The format can be six (6) digits, including a decimal point.
16	ELAPSED TEST TIME (No)	If the prompt is turned off, the medTester does not store the elapsed test time with the test record. In addition, the elapsed test time will not display or print.  If the prompt is turned on, the medTester measures the elapsed test time for the entire autosequence and stores it with the test record. The time will then display and print with the record.
17	PRINT TEST TAG (No)	This message prompts the user to print a test tag.
18	STORE RECORD (No)	After the autosequence is finished, the user is prompted to store the test record to memory and/or to print the record. If this prompt is turned off, the record is stored automatically in memory.

## Turning Prompts On and Off

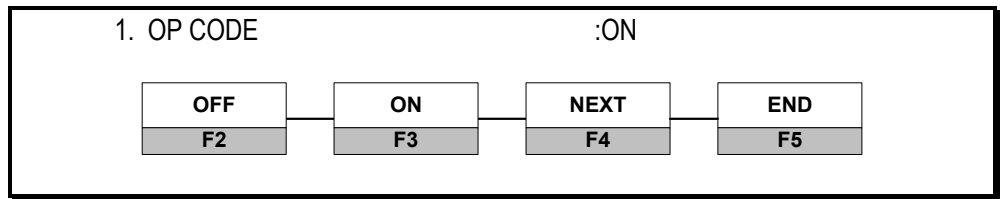
You can switch any autosequence prompt on or off. Whenever you switch off a prompt, that prompt will not appear in any autosequence. To customize these prompts, go to the prompts menu:



The medTester 5000C displays the message:

**CONFIGURE AUTOSEQUENCE PROMPTS.**

and will next display the first prompt, its on or off status, and menu items:



Select OFF, or ON. Then press NEXT to move to prompt two. If this is the only prompt or the last prompt that you want to configure, press END.

To store your prompt settings, you next see this message:

STORE AUTOSEQUENCE PROMPTS?

Press F5 if you want to store your customized prompts.

**Note**

Autosequence prompt switches are global. That means that if you turn any prompt off, **it will remain off for any type of medTester 5000C autosequence.**

## Renaming Prompts

As described in the table of prompts listed earlier in this chapter, you can rename prompt numbers 6 through 8 and 13. Whenever these prompts appear in the CUSTOM/PROMPTS instructions above, you see this option for renaming them:

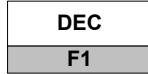
RENAME
F1

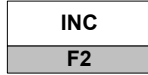
After pressing this menu item, enter the new name for the prompt.

## Pausing

Between tests in a safety autosequence, you can insert a pause for three, six, or nine seconds, or until you press any key (also called single step), so that you can view a displayed measurement for a longer or shorter period. Configure the pause or single-step feature using the menu command:



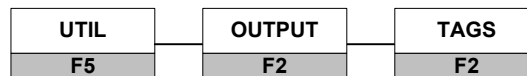
To decrement (decrease) the amount of pause time, press  to decrease the pause time in three-second periods.

To increment (increase) the amount of pause time, press  to increase the pause time in three-second periods.

## Test Tag Configuration

Upon completion of an autosequence, you may choose to print a test tag to a printer attached to the printer port or to either COM1 or COM2. In order to print a test tag, prompt number 17 (PRINT TEST TAG) must be turned on in customization/prompts as described above.

The port to which you print is configured from this menu selection:



Customize the tag to be on or off, or customize the five tag fields:

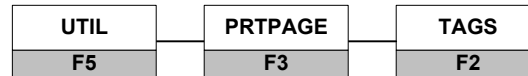


The five test tag fields are:

- **HEADER**—This is the current active header. (see *Test Record Header* above)
- **CONTROL #**
- **DATE**
- **NEXT TEST DUE DATE**
- **OP CODE**

Any or all of these fields can be turned on (to appear on the test tag) or turned off on the printed test tag. When you finish, press **END**. You can then store your tag settings.

You can set the number of lines on a test tag from this menu:



Set the number of lines to five (5) to operate the optional test label printer, Model TLP-1 & 2. This setting lets you format the label with up to five lines. For more information about using this printer, see *Test Tag Printer—Model TLP-1 & 2* in Chapter 5, *Autosequences*.

If you're using a conventional tractor-feed, dot matrix, printer, with a generic type of label (an address label, for instance), set the number of lines to six (6). Configuring these labels with six lines lets a blank line be inserted between each label. You can separate test labels by up to four (4) lines if you set the number of lines to nine (9).

## Summary of Stored Records

In medTester's main menu, under **MEMORY**, you can print a summary of all test records. (See Chapter 8, *Memory*.) The summary prints a line of text for each record with data entered into as many as six fields. Possible entries into each of the six fields are:

- **OP CODE**—The operator code.
- **TYPE**—Type of device.
- **MANF**—The manufacturer.
- **LOC**—The testing location.
- **MODEL**—The device model number.
- **SERIAL #**—Device serial number.
- **CONTROL #**—Control number.
- **EMPTY**—Used to provide empty fields in the text line.

You can customize the order of these fields so that record summaries print the way you want. You can also choose to blank-out a field if you do not want specific data to appear or if you want to include an empty field on the summary line. To format these prompts from the customization menu, enter the menu commands:





The medTester displays the number of the first field to appear on each record line in the summary. Press **F3** to scroll through the list of field names to select the first field definition; that is, which field name appears first. Use the up or down arrow keys to adjust the number of characters that each field can contain. Press **F4** to define the next field in the printed summary. Continue this process to define the remaining fields. After configuring the order and length of record summary fields, you can end and store your settings.

### Customizing Bar Code Record Data Entry

When using the Hand Held Products (HHP) Scan Gun with the medTester, you may need to configure the scanner depending on whether or not you are using it with the optional keyboard. This is accomplished by scanning different bar codes in the Scanner's Users Guide. If you don't have a hard copy of the guide for the IT3800LR, you can get it from their web site at [www.handheld.com](http://www.handheld.com), print the pages as needed, and then scan the barcodes.

To program the Scanner for use with or without keyboard, scan the appropriate barcode on the Users Guide page indicated in the following table.

HHP Scanner Configuration Barcodes		
Keyboard attached?	Barcode to scan	User Guide Page
Yes [default]	"IBM PC AT and compatibles with CR suffix"	2-1
No	"Emulate External Keyboard"	2-6

The scan for using the keyboard includes a CR suffix on each barcode read. CR is a carriage return that acts the same as pressing ENTER, thus finishing entering the text in to the medTester. You might not want CR added to each scan if you want to scan multiple barcodes on a single line. Then you need to have a CR on the last scan or press ENTER. You can program the CR separately using the scans listed in the following table.

HHP Scanner CR Configuration Barcodes		
CR Suffix?	Barcode to scan	User Guide Page
On	"Add CR suffix All Symbolologies"	4-3
Off	"Clear all Suffixes"	4-4

Follow directions, such as cycling power after reprogramming the scanner. The scanner remains programmed after cycling power on the scanner and/or the medTester.

Of the medTester autosequence prompts, you can configure eleven of them to accept multiple labels when entering data from a bar code reader. The eleven include the following:

medTester Bar Code Configurable Prompts	
	Prompt Name
1	OP CODE
2	TYPE
3	MANF
4	LOC
5	MODEL
6	SERIAL #
7	CONTROL #
8	PHYSICAL INSPECTION
9	PERFORMANCE WAVE COMMENTS
10	COMMENTS
11	NEXT TEST DUE DATE

Each bar code entry response to the prompt can include either single or multiple labels. To access this customization feature, press the right arrow on the customization menu display and select:



For each prompt number and type, select either F2 to accept a single barcode label for data entered at this prompt, or select F3 to accept multiple label data entry. For example, you could enable multiple entry input for prompt 10, *comments*. One bar code could indicate that the EUT is dirty. Another could indicate that the EUT is greasy or dented. Any or all of these conditions could be scanned into the comments section from multiple bar code entries.

All of these entries are called strings, and multiple bar codes can combine to form a string. A string ending in three spaces terminates the whole string.

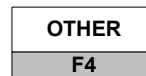
When finished with one field, you press F4 to move to the next field prompt or F5 to end customization of these prompts.

## Resetting Autosequences to Default Settings

You can always return medTester 5000C autosequences to the default settings by reinitializing the medTester. Safety autosequences require you to indicate whether you want to include power-off tests, reverse polarity tests, and open neutral tests. To access this feature for the safety autosequences, press the right arrow on the custom menu display, and enter the menu commands:



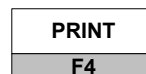
To return to the default settings for other types of autosequences, such as defibrillation or IV pump, select the desired type from the custom initialization menu. To initialize all custom features to default, press the right arrow from the custom initialization menu, then press:



Pressing **other** sets all customized features to the factory default settings. For more information about these settings, see *Factory Default Settings* in Chapter 2, *Installation*.

## Printing Your medTester 5000C Configuration

With a printer connected to the printer port on the back panel of your medTester 5000C, you can print out your configuration of the medTester by entering these commands:



## Customize medTester 5000C Options

The descriptions of autosequence customizing features in this chapter apply as well to other autosequences. If your medTester 5000C includes the defibrillator and/or IV pump modules, you can customize those autosequences tool. For more information see:

- Chapter 9, *Defibrillator Module*.
- Chapter 10, *IV Pump Module*.
- Chapter 14, *ESU Module*.
- Chapter 15, *SPO2 Module*.



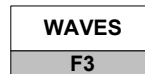
# Chapter 7

## Performance Waves

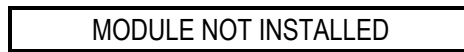
*In this chapter, you learn how to output performance waveforms to test patient monitors using the medTester 5000C.*

### Outputting Performance Waves

With the Waveform/Extended Testing module installed on your medTester 5000C, you can output performance waves. To verify whether your medTester has this option, do the following. From menu one, press:



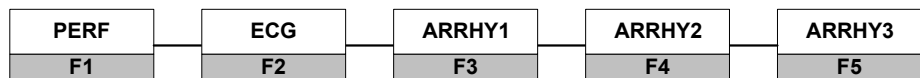
If the module is not installed, this message appears on the display:



If the module is installed, you see this message displayed:



The wave group names appear below the medTester message as follows:



When you press the function on the medTester keyboard for the waveform group you want, the waveform names from the table in the following section appear on the display.

## Waveform Groups

You can generate any of the waveforms listed in the five groups in the table below for the testing of patient monitors. The table's first column lists the names of the waveforms as they appear in the medTester 5000C display. Column two describes the display names, and column three shows the remote command for each waveform.

WAVEFORM GROUPS		
medTester 5000C Display Wave Menu Name	Description	Remote Command
<b>Group Name: PERF</b>		
2Hz SQ	2 Hz Square	W001
4 Sec	4 Second Pulse	W002
10Hz	10 Hz Sine Wave	W003
40Hz	40 Hz Sine Wave	W004
60Hz	60 Hz Sine Wave	W005
100Hz	100 Hz Sine Wave	W006
1KHz	1 kHz Square Wave	W007
1HzTRI	2 Hz Triangle	W008
CMRR	60 Hz Common Mode Rejection Test	W009
.5Hz	0.5 Hz Sine Wave	W014
<b>Group Name: ECG</b>		
30BPM	Normal Sinus ECG at 30 Beats Per Minute (BPM)	W010
60BPM	Normal Sinus ECG at 60 BPM	W011
120BPM	Normal Sinus ECG at 120 BPM	W012
240BPM	Normal Sinus ECG at 240 BPM	W013
<b>Group Name: ARRHY1</b>		
AFIB	Atrial Fibrillation 1, Course	W015
2°BLK1	2nd Degree A-V Block, Type 1, Wenckebach	W016
PAC	Premature Atrial Contractions	W017
MB80	Missed Beat at 80 BPM	W018
MB120	Missed Beat at 120 BPM	W019
<b>Group Name: ARRHY2</b>		
PVC1	PVC Type 1, Left	W020
PVC2	PVC Type 2, Right	W021
MFPVC	Multi-focal PVCs	W022
PVCRT	PVC 1, R on T	W023

WAVEFORM GROUPS		
medTester 5000C Display Wave Menu Name	Description	Remote Command
PAIR	A Pair or Couplet of PVCs	W024
<b>Group Name: ARRHY3</b>		
RUN5	Run of 5 PVCs	W025
RUN11	Run of 11 PVCs	W026
RBBB	Right Bundle Branch Block	W027
VTACH	Ventricular Tachycardia at 180 BPM	W028
VFIB	Ventricular Fibrillation	W029
ASYS	Asystole 2, Flat	W030

**Note**

For more information about using remote commands, see Chapter 12, *Remote Operation*.

## Running Waveforms from The WAVES Menu

To turn on any of the waveforms, follow these instructions:

- 1.** Attach the patient leads from the EUT (patient monitor) to the binding posts on the medTester 5000C.
- 2.** Power on the EUT. Note that, for your convenience, you can plug the patient monitor into the medTester's test receptacle since test receptacle power is on when running any waveform.
- 3.** Press the desired medTester function keys to access the wave menu item. The medTester outputs the selected waveform to the patient monitor.

### Note

You can change waves in a group by selecting a new wave, or you can press **ESC** and change to a wave in another group. Waves continue to run when changing groups. Press **ESC** twice to exit waves and turn off the running waveform.



## Conducting Waveform Tests in Safety Autosequences

You can execute performance wave tests at the end of any safety autosequence. The medTester 5000C prompts you to begin or to skip these tests.

When performance waveforms are generated within a safety autosequence, they follow this sequence for the listed periods of time:

Performance Waveforms in Safety Autosequences	
Waveform Name	Test Duration (In Seconds)
2 Hz Square	Continuous
4 sec Step	8
10 Hz Sine	4
40 Hz Sine	4
60 Hz Sine	60
100 Hz Sine	4
1 kHz Square	4
2 Hz Triangle	Continuous
CMRR 60 Hz	Continuous
ECG 60 BPM	Continuous
ECG 30 BPM	30
ECG 60 BPM	30
ECG 120 BPM	30
ECG 240 BPM	30

### Note

Tests with a predefined duration automatically end or can be terminated at any time by pressing (NEXT). Those marked *continuous* can be terminated by pressing NEXT.



# Chapter 8 Memory

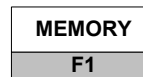
*This chapter acquaints you with the medTester 5000C memory module options you may have installed on your medTester.*

## Introduction

The medTester 5000C offers you two memory module options that you can use to store test records—*100 Record (3)* and *Expanded Memory(4)*. If you're unsure if your medTester has a memory module installed, do this:

1. From the main menu, MENU1, press the right arrow to access MENU2.

2. Enter the menu command:



If the module is not installed, this message appears on the display:

MODULE NOT INSTALLED

In addition, to store checklists your medTester needs to have the medCheck module. Test records are gathered from autosequences and checklists, and are stored and numbered sequentially. In order to print records, you need the RS-232/Printer Port Module. Once you have conducted an autosequence or checklist and stored records, you can take advantage of the medTester 5000C's memory features.

**Note**

All medTester memory functions begin on MENU2 as described above.

## Viewing A Single Record

You can view recorded tests from the medTester display.

VIEW
------

F1
----

1. Enter the menu command:
2. The medTester prompts you: RECORD # TO VIEW. The total number of records is displayed in parentheses. Enter the desired record number.
3. View the record by scrolling through it with the up and down arrow keys.

## Printing Records

You can print records in a variety of ways with the printing option. To access print options, enter the menu command:

PRINT
-------

F2
----

### Print A Single Record

SINGLE
--------

F1
----

1. Enter the menu command:
2. Select the number of the record you want to print.

### Print A Range of Records

RANGE
F2

1. Enter the menu command:
2. The display prompts you to PRINT FROM RECORD # with the total number of stored record numbers displayed in parentheses. Enter the number of the first record you want to print.
3. The display then prompts you to enter the number of the last record you want to print with this message: PRINT THROUGH RECORD #.
4. The medTester prints the selected record(s) with the message: PRINTING RECORDS # THROUGH #.

### Print All Records

ALL
F3

1. Enter the menu command:
2. All stored records are printed.

### Print Records by Type

The medTester 5000C can also print all records by type. You can print all safety test records, for example. Or if you have medTester modules installed for defibrillator, IV pump, checklists, etc., you can print those types of records too. To print records by type, from the print menu enter the menu command:

TYPE
F4

Next access the type of records you want to print. From menu one, you can access these types:

- |               |
|---------------|
| <b>SAFETY</b> |
| <b>F1</b>     |

 Prints all stored safety record results.
- |              |
|--------------|
| <b>DEFIB</b> |
| <b>F2</b>    |

 Prints all defibrillator records.
- |               |
|---------------|
| <b>IVPUMP</b> |
| <b>F3</b>     |

 Prints all IV pump records.
- |            |
|------------|
| <b>ESU</b> |
| <b>F4</b>  |

 Prints all ESU records.
- |             |
|-------------|
| <b>SPO2</b> |
| <b>F5</b>   |

 Prints all SPO2 records.

From menu one, press the right arrow to access these record types:

- |              |
|--------------|
| <b>PACER</b> |
| <b>F1</b>    |

 Prints all PACER records.
- |             |
|-------------|
| <b>NIBP</b> |
| <b>F2</b>   |

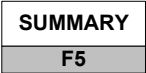
 Prints all non-invasive blood pressure records.
- |                  |
|------------------|
| <b>CHECKLIST</b> |
| <b>F4</b>        |

 Prints all checklist records.

If no records exist for a type, a message displays. If the type module is not installed, that message displays.

**Printing A Summary of Records**

You can print a summary of all records stored from the menu command:

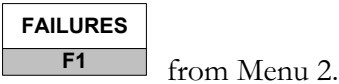


The summary prints one line of text per record which you can program for your specific needs; see Chapter 6 *Customize Your medTester 5000C*. Each line can contain six fields with as many as 20 characters per field. You can customize each field to be one of the following:

- OP CODE—The operator code.
- TYPE—The type of device.
- MANF—The device manufacturer.
- LOC—The testing location.
- MODEL—The device model number.
- SERIAL #—The device serial number.
- CONTROL #—The device control number.
- EMPTY—Used to provide empty fields in the text line.

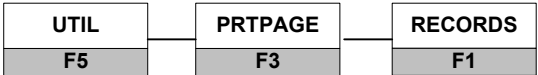
**Printing Failed Test Records**

You can print only those records for equipment that failed any test. To do this, enter the menu command:

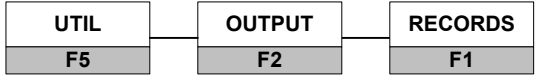


**Configuring Your Printer**

You can set the printer page from 1-99 lines so that the medTester inserts page breaks for printing multiple page records. If this is set to zero, page breaks will not insert. Configure the printer page through these menu commands:

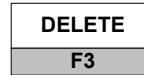


You can print records through the printer port or either COM port. Configure ports for test record output with these menu commands:



## Deleting Records

If you want, you can delete a single record with this command:



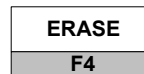
The medTester asks you to enter the number of the record to delete. You then see this prompt:

ARE YOU SURE YOU WANT TO DELETE RECORD xxx?

Press YES to confirm or Esc to cancel the command and to escape. After deleting a record, subsequent record numbers are reassigned.

## Erasing Memory, All Records, and Checklists

To erase all records in memory, enter this menu command:



After entering this command, medTester prompts:

ERASE ALL RECORDS?

Press YES to confirm, or No or Esc to cancel the command and to escape. After erasing all records, you can erase all checklists in a similar manner with a prompt asking if you want to erase all checklists.

## Checking Contents of Memory

You can check the contents of memory by entering the menu command:



After entering this command, use the down arrow key to move down through a list of memory checks or the up arrow key to move up:

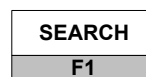


1. Free Memory—In bytes.
2. Total Memory and Checklists—Amount of total memory and the amount used by checklists.
3. Total Test Record Memory—Shows you total bytes of test record memory, the number of bytes used, and the number of bytes free.
4. Total Test Records, Safety and Toolbox—Displays the total test records and the numbers of safety and toolbox records.
5. Checklist—The number of stored checklist records. For more information about checklists, see Chapter 11, medCheck Module.
6. Defib—The number of defibrillator autosequence records.
7. IV Pump—Number of IV pump autosequence records stored.
8. ESU – The number of ESU Autosequence records
9. SpO2 – The number of ESU Autosequence records

## Searching for Records

You can search for records by entering a search string. For example, if you want to search for all records that match an operator, type in an operator's code, press **Ent**, and the medTester searches for all records that match that code.

To search from the Memory menu, press the right arrow and enter the menu command:



Enter the search string. If the medTester locates any records, it displays the message:

STRING FOUND IN RECORD

That indicates the number of the first record which contains the string. You can view or print the data in the found record. You can press **NEXT** to search for the same string in subsequent records. You can then view or print the next record.

If no records are found that match the entered string, the medTester displays the message:

STRING NOT FOUND
------------------

### **Searching for Records with Test Failures**

There may be times when you want to search for any test records that contain failed tests. The process of searching for them is similar to searching for any test record. Under the **MEMORY** menu, press the right arrow to access this command:

<b>FAILURES</b>
<b>F2</b>

### **Printing Checklists**

You can print out all checklists with the command:

<b>PCHECK</b>
<b>F4</b>

## Keyboard Shortcut Commands

In addition to accessing memory functions through menu commands, you can also enter keyboard shortcut commands directly into the medTester 5000C at either main menu one (1) or two (2). You enter these commands as text strings and directly arrive at the function rather than stepping through the menu.

KEYBOARD SHORTCUT COMMANDS	
Shortcut Command	Menu Command
VIEW	MEMORY/VIEW
PRT	MEMORY/PRINT/SINGLE (record)
PRNG	MEMORY/PRINT/RANGE (of records)
PALL	MEMORY/PRINT/ALL (records)
PSAF	MEMORY/PRINT/TYPE/SAFETY (print safety records)
PFIB	MEMORY/PRINT/TYPE/DEFIB (print defibrillator records)
PIVP	MEMORY/PRINT/TYPE/IVPUMP (print IV Pump records)
PESU	MEMORY/PRINT/TYPE/ESU (print ESU records)
PSPO2	MEMORY/PRINT/SPO2 (print SPO2 records)
PPACER	MEMORY/PRINT/TYPE/PACER (print PACER records)
PNIBP	MEMORY/PRINT/TYPE/NIBP (print NIBP records)
PCHK	MEMORY/PRINT/TYPE/CHECK (print checklists)
PSUM	MEMORY/PRINT/SUMMARY (print summary of records)
PRTF	MEMORY/PRINT/FAILURES (print records with test failures)
DEL	MEMORY/DELETE (delete records)
ERA	MEMORY/ERASE (erase all records)
FREE	MEMORY/FREE (check memory usage)
SRH	MEMORY/SEARCH (search for records)
SRHF	MEMORY/FAILURES (search for records with test failures)



# Chapter 9

## Defibrillator Module

*In this chapter you learn about using the medTester 5000C to control defibrillator autosequence tests with Fluke Biomedical defibrillator analyzers, what these tests are, and how to use them.*

### Defibrillator Autosequences

By installing the Defibrillator module (8) in your medTester 5000C, you have the capability of using a set of 20 autosequences for testing defibrillators with a Fluke Biomedical defibrillator analyzer and collecting test data. The Fluke Biomedical Impulse 4000 or Impulse 3000 connects to the COM2 Port or defined Wedge Port if applicable on your medTester which then lets you test the defibrillators that are on the market today and store test measurements in the medTester 5000C for your equipment management system.

When you connect the Impulse 4000 or Impulse 3000 to your medTester and run defibrillator autosequences, the medTester displays prompts for your defibrillator setup and testing and executes tests. The Impulse returns measurement readings to the medTester, which displays them for you. If you have the medTester 5000C RS-232/Printer module and the Memory module, you can store and print test records.

Having the Defibrillator module also offers you the ability to incorporate these autosequences into checklists if your medTester 5000C has the medCheck module installed.

For related information, see these chapters in this manual:

- Chapter 5, *Autosequences*.
- Chapter 6, *Customize Your medTester 5000C*—for customizing autosequences.
- Chapter 8, *Memory*—for test record storage and printing.

**Note**

Consult your Impulse 3000 or Impulse 4000 operators manual for proper operation of your Impulse model.

To discover if you have the Defibrillator module installed on your medTester 5000C, enter these menu commands:



If defibrillator autosequences are installed, you see this message displayed:

**SELECT DEFIB AUTOSEQUENCE TO RUN**

The autosequence names appear below the message. To begin working with these autosequences, look at the table of defibrillator autosequence names.

If the Defibrillator module has not been installed, this message appears on the display:

**MODULE NOT INSTALLED**

If the module was installed and you get this message, it may be necessary to re-enable the module. Refer to the “Enabling Modules” section of Chapter 2 – Installation.

### Defibrillator Autosequence Names

You can begin any of the autosequences listed below from the medTester menu commands or by entering the keyboard shortcut command directly into the medTester. You can also include defibrillator autosequences as items in checklists. For more information about checklists, see Chapter 11, *medCheck Module*. See Chapter 12, *Remote Operation*, for information about remote mode of operation.

DEFIBRILLATOR AUTOSEQUENCES						
Autosequence Name	Keyboard Shortcut Command	Menu Commands				
		from				
		<table border="1" style="display: inline-table; border-collapse: collapse;"> <tr> <td style="padding: 2px;">AUTO</td> <td style="padding: 2px;">DEFIB</td> </tr> <tr> <td style="padding: 2px;">F1</td> <td style="padding: 2px;">F2</td> </tr> </table>	AUTO	DEFIB	F1	F2
AUTO	DEFIB					
F1	F2					
LP4	A30	<table border="1" style="display: inline-table; border-collapse: collapse;"> <tr> <td style="padding: 2px;">LP4</td> </tr> <tr> <td style="padding: 2px;">F1</td> </tr> </table>	LP4	F1		
LP4						
F1						
LP5	A31	<table border="1" style="display: inline-table; border-collapse: collapse;"> <tr> <td style="padding: 2px;">LP5</td> </tr> <tr> <td style="padding: 2px;">F2</td> </tr> </table>	LP5	F2		
LP5						
F2						
LP6	A32	<table border="1" style="display: inline-table; border-collapse: collapse;"> <tr> <td style="padding: 2px;">LP6</td> </tr> <tr> <td style="padding: 2px;">F3</td> </tr> </table>	LP6	F3		
LP6						
F3						
LP6S	A33	<table border="1" style="display: inline-table; border-collapse: collapse;"> <tr> <td style="padding: 2px;">LP6s</td> </tr> <tr> <td style="padding: 2px;">F4</td> </tr> </table>	LP6s	F4		
LP6s						
F4						
LP7	A34	<table border="1" style="display: inline-table; border-collapse: collapse;"> <tr> <td style="padding: 2px;">LP7</td> </tr> <tr> <td style="padding: 2px;">F5</td> </tr> </table>	LP7	F5		
LP7						
F5						
LP8	A35	<table border="1" style="display: inline-table; border-collapse: collapse;"> <tr> <td style="padding: 2px;">LP8</td> </tr> <tr> <td style="padding: 2px;">F1</td> </tr> </table>	LP8	F1		
LP8						
F1						
M/D3	A36	<table border="1" style="display: inline-table; border-collapse: collapse;"> <tr> <td style="padding: 2px;">M/D3</td> </tr> <tr> <td style="padding: 2px;">F2</td> </tr> </table>	M/D3	F2		
M/D3						
F2						
78660A	A37	<table border="1" style="display: inline-table; border-collapse: collapse;"> <tr> <td style="padding: 2px;">78660A</td> </tr> <tr> <td style="padding: 2px;">F3</td> </tr> </table>	78660A	F3		
78660A						
F3						
NK7000	A38	<table border="1" style="display: inline-table; border-collapse: collapse;"> <tr> <td style="padding: 2px;">NK7000</td> </tr> <tr> <td style="padding: 2px;">F4</td> </tr> </table>	NK7000	F4		
NK7000						
F4						
AOLOWN	A39	<table border="1" style="display: inline-table; border-collapse: collapse;"> <tr> <td style="padding: 2px;">AOLOWN</td> </tr> <tr> <td style="padding: 2px;">F5</td> </tr> </table>	AOLOWN	F5		
AOLOWN						
F5						
M/D4	A40	<table border="1" style="display: inline-table; border-collapse: collapse;"> <tr> <td style="padding: 2px;">M/D4</td> </tr> <tr> <td style="padding: 2px;">F1</td> </tr> </table>	M/D4	F1		
M/D4						
F1						
M/D2	A41	<table border="1" style="display: inline-table; border-collapse: collapse;"> <tr> <td style="padding: 2px;">M/D2</td> </tr> <tr> <td style="padding: 2px;">F2</td> </tr> </table>	M/D2	F2		
M/D2						
F2						

DEFIBRILLATOR AUTOSEQUENCES						
Autosequence Name	Keyboard Shortcut Command	Menu Commands				
		from				
		<table border="1"> <tr> <td><b>AUTO</b></td> <td><b>DEFIB</b></td> </tr> <tr> <td><b>F1</b></td> <td><b>F2</b></td> </tr> </table>	<b>AUTO</b>	<b>DEFIB</b>	<b>F1</b>	<b>F2</b>
<b>AUTO</b>	<b>DEFIB</b>					
<b>F1</b>	<b>F2</b>					
M/D2J	A42	<table border="1"> <tr> <td><b>M/D2J</b></td> </tr> <tr> <td><b>F3</b></td> </tr> </table>	<b>M/D2J</b>	<b>F3</b>		
<b>M/D2J</b>						
<b>F3</b>						
78670A	A43	<table border="1"> <tr> <td><b>78670A</b></td> </tr> <tr> <td><b>F4</b></td> </tr> </table>	<b>78670A</b>	<b>F4</b>		
<b>78670A</b>						
<b>F4</b>						
43100A	A44	<table border="1"> <tr> <td><b>43100A</b></td> </tr> <tr> <td><b>F5</b></td> </tr> </table>	<b>43100A</b>	<b>F5</b>		
<b>43100A</b>						
<b>F5</b>						
ZOLL	A45	<table border="1"> <tr> <td><b>ZOLL</b></td> </tr> <tr> <td><b>F1</b></td> </tr> </table>	<b>ZOLL</b>	<b>F1</b>		
<b>ZOLL</b>						
<b>F1</b>						
LP10	A46	<table border="1"> <tr> <td><b>LP10</b></td> </tr> <tr> <td><b>F2</b></td> </tr> </table>	<b>LP10</b>	<b>F2</b>		
<b>LP10</b>						
<b>F2</b>						
blank (user-defined)	A47-A49	<table border="1"> <tr> <td><b>blank</b></td> </tr> <tr> <td><b>F3-F5</b></td> </tr> </table>	<b>blank</b>	<b>F3-F5</b>		
<b>blank</b>						
<b>F3-F5</b>						



## Running Defibrillator Autosequence Tests

To begin running defibrillator autosequence tests, connect your medTester 5000C to your Impulse 4000 or Impulse 3000. These two instruments are connected through the COM2 port on the medTester and the RS-232 serial port on the Impulse model you have.

### Note

Refer to Chapter 1, *General Information- Accessories*, or the current Fluke Biomedical Price List for the correct serial cable part number needed.

From the medTester 5000C defibrillator menu, select the autosequence name for the autosequence you wish to run. The name and number of the selected autosequence appears on the display followed by the prompt:

Press F5 for all device info prompts

If a safety autosequence has executed since power up of the medTester, you can have the medTester use the previously input prompt information for the current defibrillator autosequence, from this prompt:

USE PREVIOUS STARTING INFORMATION?

<b>YES</b>	<b>NO</b>
<b>F1</b>	<b>F2</b>

To accept previously input prompt information, press YES, and go to *Test Sequence*, which follows this section. If you choose NO, go to the prompt instructions in *Pretest Device Prompts*.

## **Pretest Device Prompts**

There are eight prompts for information that can appear in the autosequence test record. After selecting the desired autosequence, the medTester 5000C prompts you to enter device prompts. If you have some or all prompts turned off, the autosequence still gives you the opportunity to enter device information with the message:

Press F5 for all device info prompts

- 1.** OP CODE—This is the operator code for the person doing the testing. This code can consist of a maximum of three characters which can be entered from the medTester keyboard. An example of an operator code could be a person's initials or employee number. The previous operator's code, if any, will appear. If the current operator has not changed from previous use, press the ENT key.
- 2.** TYPE—Enter the device name, code, or other descriptor for the equipment under test. This entry can be a maximum of 16 characters.
- 3.** MANF—Enter the name of the device manufacturer, 16 characters maximum.
- 4.** LOC—Type in the location of the device, 16 characters maximum. The previous location, if any, will appear. If this occurs and is the desired location, press the ENT key.
- 5.** MODEL—Enter the device model number, 16 characters maximum.
- 6.** SERIAL #—Type the device serial number, again 16 characters maximum.
- 7.** CONTROL #—Enter a control number with a maximum of 16 characters.
- 8.** PHYSICAL INSPECTION—You have two physical inspection lines, each of which can consist of a maximum of 40 characters. After entering data for the first prompt, the second prompt appears.

**Note**

See Chapter 5, *Autosequences*, for a complete explanation of working with prompts. You can turn individual prompts on or off and rename prompts six through eight (6-8) from the list above. Chapter 6, *Customize Your medTester 5000C*, explains how to customize prompts.

**Test Sequence**

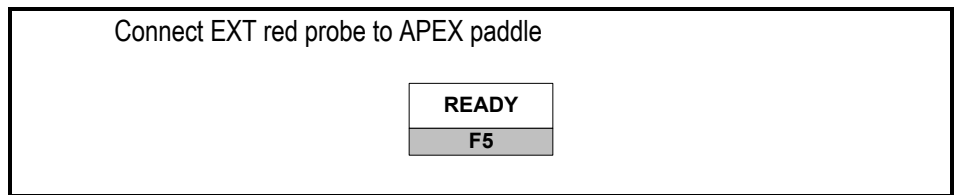
After you input pretest prompt information, defibrillator tests execute in the order described below.

Plug the defibrillator (the EUT, equipment under test) into an appropriate power source.

**Note**

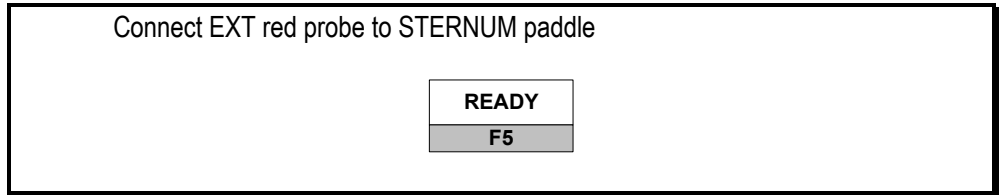
Since defibrillators may produce electrical noise that could interfere with test measurements on the medTester 5000C, it is advised to plug the defibrillator into another power receptacle. However, during any paddle tests, the defibrillator must be plugged into the medTester 5000C's test receptacle.

**APEX Paddle.** The APEX paddle test performs two (2) leakage measurements. One with closed ground; the other with open ground. Both measurements are taken under normal polarity and closed neutral conditions. Before these tests execute, this message displays:



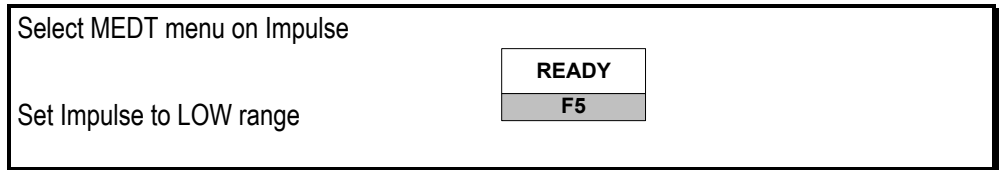
Press **READY** to begin the tests. Measurements are in  $\mu\text{A}$  RMS.

**Sternum Paddle.** The sternum paddle test is similar to the APEX paddle test. Two (2) leakage measurements are taken, again with closed ground and with open ground. Both measurements are taken under normal polarity and closed neutral conditions. Before these tests execute, this message displays:



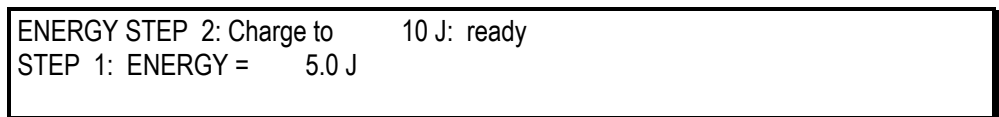
Press READY to begin the tests. Measurements are in  $\mu\text{A}$  RMS.

**Energy Tests.** Energy tests execute in the low range and again in the high range. *Low Range* is defined as 0-50 joules, and *High Range* is greater than 50 joules. Defibrillator autosequences are set at the factory so that low range energy step tests execute before high range energy step tests. You can customize your defibrillator testing so that this order is reversed. Prior to executing these tests, this message appears in the medTester 5000C display:



When you are prepared to begin the tests, press READY. Next follow these steps:

1. Charge the EUT (the equipment under test—defibrillator you're testing) to the energy level prescribed in the medTester 5000C display.
2. Discharge the defibrillator into the Impulse paddle contacts, and press the down arrow key on the medTester. The reading sent to the Impulse appears on the bottom medTester display line with instructions for the next energy step displayed on the top line. Here's an example display of this information:



**Out-of-Limits Reading**

When a reading is out of limits, a # sign appears next to the reading with the statement: **Out of limits**. Both the high and low limits will appear. Whenever this occurs, you can repeat the test or continue with the remaining steps. Press **F4** to repeat the test or **F5** to continue to the next step.

In order to flag a defib reading as out of limit, the reading must exceed the programmed test limit percentages ( $\pm$ ) and differ from the expected step energy value by more than one (1.0) joule. This out-of-limit determination technique allows for a wider range of acceptable reading at the lower energy settings which is typical of defibrillator specifications. For example, a defibrillator can have a  $\pm$  50 percent tolerance at the low 2.0 joule (1.0-3.0) which is covered by the  $\pm$  1.0 joule test limit and could have failed if only a  $\pm$  10 percent (1.8-2.2) test limit was used.

After the low range steps execute, you receive a prompt to set the Impulse to the high range:



You can now execute the high range energy tests. These steps occur in the same order as described above.

**Note**

You can skip an energy step by pressing the down arrow key on the medTester. Whenever you do this, the energy reading line displays the nominal value for the step followed by an X. Here's an example: ENERGY = 100.X J.

**MAX Energy Test.** This test measures the maximum length of time the EUT requires to charge to its maximum energy level. The test also measures the actual energy level. To perform this test do the following:

1. Simultaneously push **START (F5)** and start charging the defibrillator to its maximum energy level.
2. The next display shows:

MAX ENERGY: ready

3. The defibrillator discharges to the Impulse, and the reading displays on the medTester similar to this example:

CHARGE TIME = 14 S	REPEAT	CONTINUE
MAX ENERGY = 400.X J	F4	F5

4. Either repeat the test or continue to the Cardioversion test as desired.

**Cardioversion Test.** If this test is turned on in the custom menu, you can perform the test:

1. Connect the ECG leads to the binding posts on the Impulse.
2. The Impulse outputs a waveform to the EUT. The type of waveform is dependent upon the Impulse model you have.
3. View the waveform that is output on your defibrillator monitor.
4. Set your EUT (defibrillator) to *Cardioversion Synchronized* mode.
5. Discharge the EUT.
6. Each step in the test causes the medTester to display the readings similar to this example:

CARDIOVERSION TEST STEP 2: ready  
STEP 1: DELAY = YYY mS ENERGY = XXX.X J

7. This process continues through steps two and three.

The table below supplies specific information about the tests for each autosequence.

<b>Autosequence Name</b>	<b>Energy Step High Limit (%)</b>	<b>Energy Step Low Limit (%)</b>	<b>Max Energy High Limit (Joules)</b>	<b>Max Energy Low Limit (Joules)</b>	<b>Paddle Leakage and/or Cardioversion</b>	<b>Energy Steps (Joules)</b>
LP4	10	10	480	418	Cardioversion	10, 25, 50, 100, 200, 300, 400, 450
LP5	10	10	396	324	Cardioversion	20, 50, 100, 200, 300, 360
LP6	10	10	428	372	Both	5, 10, 20, 30, 50, 100, 200, 300, 400
LP6S	10	10	385	335	Both	5, 10, 29, 30, 50, 100, 150, 200, 300, 360
LP7	10	10	385	335	Both	5, 10, 20, 30, 50, 100, 200, 300, 360
LP8	10	10	385	335	Both	2, 5, 9, 10, 20, 30, 50, 100, 150, 200, 300, 360
M/D3	10	10	440	360	Both	5, 10, 20, 40, 60, 100, 150, 200, 250, 300, 360
78660A	10	10	400	330	Both	5, 10, 20, 40, 60, 100, 150, 200, 250, 300, 360
NK7000	10	10	396	324	Both	3, 5, 10, 20, 30, 50, 70, 100, 150, 200, 300, 360
AOLOWN	15	15	414	306	Both	5, 10, 20, 30, 50, 100, 150, 200, 300, 360
M/D4	20	20	384	256	Both	1, 8, 40, 80, 160, 240, 320
M/D2J	10	10	506	404	Both	5, 10, 20, 40, 75, 100, 200, 300, 400, 460
78670A	15	15	414	306	Both	5, 10, 20, 30, 50, 70, 100, 150, 200, 300, 360
43100A	15	15	414	306	Both	2, 3, 5, 7, 10, 30, 50, 70, 100, 150, 200, 300, 360
ZOLL	10	10	396	324	Both	2, 3, 5, 7, 10, 30, 50, 100, 150, 200, 300, 360
LP10	10	10	396	324	Cardioversion	5, 10, 20, 50, 100, 200, 300, 360
3 blanks (user-defined)						

## Posttest Prompts

When all tests are completed, the medTester 5000C can prompt you for:

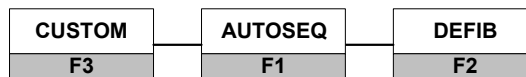
1. COMMENTS
2. NEXT TEST DUE DATE
3. USER TIME
4. PRINT TEST TAG
5. STORE or PRINT TEST RECORD

## Customizing Defibrillator Autosequences

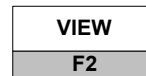
(For detailed information about customizing autosequences, please refer to Chapter 6, *Customize Your medTester 5000C*.)

To begin customizing defibrillator autosequences, you can view any of your current ones by entering these menu commands:

1. From the main menu, MENU1, press the right arrow to access MENU2.
2. Enter the menu commands:



3. From the DEFIB menu, select:
4. Now select the autosequence you want to view.
5. Finally scroll through the steps in the sequence by using your up and down arrow keys.



## Make Your Own Autosequence

You can customize the 17 preprogrammed defibrillator autosequences or create three new ones with the blank sequences. This section describes the menu steps that you use to customize, or create, autosequences. Note that each customized autosequence can include as many as 20 energy step values. After you enter the energy step value (in joules) you want, the medTester prompts you for more energy steps, if desired. If you do not want further energy steps in your autosequence, you can press END.

### Note

You can find detailed information about customizing autosequences in Chapter 6, *Customize Your medTester 5000C*.



Begin by accessing the custom, autosequence, defib menu as described earlier. This time, select:



Next select the name of the autosequence you want to customize or create. Follow these steps, providing the desired information:

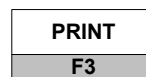
1. Name—This is the name you want to give to the autosequence, with a maximum of six characters.
2. Menu Steps:
  - Energy step high limit.
  - Energy step low limit.
  - Maximum energy high limit.
  - Maximum energy low limit.
  - Energy step values (a maximum of 20 allowed).
  - Paddle leakage tests (you're prompted to keep or remove the tests).
  - Cardioversion tests (you're prompted to keep or remove the tests).

After customizing your autosequence, the medTester prompts you to store the autosequence:



**Print Your Autosequence**

From the defibrillator custom autosequences menu described above, printing any autosequence is accomplished through this menu command:

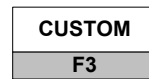


### Reinitialize Factory Default Settings

Any customized autosequences can be returned to the factory default settings. To do this, enter these medTester commands:

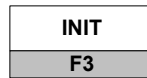
1. From the medTester 5000C main menu, MENU1, press the right arrow to access MENU2.

2. Enter the command:

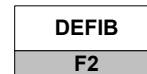


3. From the custom menu, press the right arrow and enter the

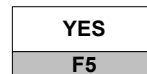
command:



4. Choose:



5. To initialize defibrillator autosequences to defaults, press:



#### Note

Reinitializing will return all customized or created autosequences to factory default settings, including three blanks.

# Chapter 10

## IV Pump Module

*In this chapter you learn about using the medTester 5000C to control IV pump autosequence tests with a Fluke Biomedical IV pump analyzer.*

### IV Pump Autosequences

If your medTester 5000C includes the Intravenous (IV) Pump Module (9), you have ten autosequences for testing IV pumps with a Fluke Biomedical IV pump analyzer. You can use the IDA 4 Plus, the Infutest 2000 Series D, the IPT-1, or the IPT-MC IV pump analyzer. Five of the autosequences come preprogrammed from the factory, however, you can customize all ten autosequences to meet your needs. IV pump autosequences allow you to connect the IV pump analyzer to your medTester 5000C's COM2 port or defined wedge port if applicable. You then initiate performance tests on the medTester that sends commands to the IV pump analyzer. Measurement readings from the IV pump you are testing (the EUT—equipment under test) display on the medTester and store to medTester memory for printing and equipment management data collection.

You gain further functionality by including IV pump autosequences in checklists. As with the defibrillator module, the IV Pump Module gives you a comprehensive testing and data collection system for your organization's equipment.

#### **Configuring for Your IV pump analyzer.**

The medTester can only be configured for one type of IV pump analyzer at a time, the IDA 4 Plus, the Infutest 2000 Series D, the IPT-1, or the IPT-MC. All autosequences stored by initialization, customization, or remote download will only work with the instrument for which they were designed.

Use the CUSTOM / AUTOSEQ / IVPUMP / TYPE menu path to configure the medTester for a specific IV pump analyzer.

1. Press a function key to select the desired type: **F1** (IDA 4P); **F2** (IPT-1); **F3** (IPT-MC); or **F4** (INFUTEST). The selection is displayed.
2. Press **F5** (STORE) to store the selection in non-volatile EEPROM memory. From this point, all customized autosequences will be for the selected IV Pump analyzer.
3. After changing the IV Pump analyzer type, reinitialize IV Pump autosequences, or customize them so that they are compatible with the test device designated. See “Reinitialize Factory Default Settings” (page 150).

### **Basic Test Format**

Each step in an autosequence performs a flow test. There are various types of flow tests depending on the IV pump analyzer. The types, flow rate, accuracy limits, and end type for the steps are programmed into the autosequence.

For each step, after the flow test, you can run an optional pressure test, which measures the peak occlusion pressure and the elapsed time to reach the peak.

### **IV Pump Analyzers**

You can use any of four Fluke Biomedical IV pump analyzers to run IV pump tests. Please refer to the analyzer operator's manual for more information. Note that the medTester can only be configured for one type of IV pump analyzer at a time, the IDA 4 Plus, the Infutest 2000 Series D, the IPT-1, or the IPT-MC. All autosequences stored by initialization, customization, or remote download will only work with the instrument for which they were designed.

#### **IDA 4 Plus**

The IDA 4 Plus can run three types of tests: single-rate, dual-rate, or PCA (patient controlled analgesia). Even though the IDA 4 can run up to 4 channels simultaneously, the medTester 5000C is only able to control one channel. When customizing autosequences for the IDA 4 Plus, follow the instructions for the Infutest in the medTester 5000C Operators Manual. The factory-default autosequences for the IDA 4 Plus are also the same as for the Infutest.

### **Infutest 2000 Series D**

The Infutest can run three types tests: single rate tests, dual rate tests, and PCA (patient controlled analgesia) tests. Even though the Infutest 2000 series D can run up to 4 channels simultaneously, the medTester 5000C is only able to control one channel. The medTester 5000C always controls Infutest 2000 Series D channel A to run a test.

### **IPT-1**

With the IPT-1, you can perform 2 types of flow tests: steady flow and high accuracy.

### **IPT-MC**

The IPT-MC only has 1 type of flow test. Even though the IPT-MC can run up to 4 channels simultaneously, the medTester is only able to control one channel. The medTester 5000C always controls IPT-MC channel 1 to run a test.

### **Terminating A Flow Rate Test**

You can terminate a flow rate test automatically or manually. Automatic termination occurs after a preset time has elapsed or after a preset volume has been measured. The advantage of an automatic test termination is that you do not need to constantly monitor the progress of each flow rate measurement. The medTester beeps when the test is complete. In addition to having a test automatically terminated, you can manually end a test at any time during the flow rate measurement.

**Note**

In order to take advantage of IV pump autosequences, your medTester 5000C requires the IV Pump Module, RS-232/Printer module and the Expanded Memory module. Other helpful modules include medCheck (for downloading checklists from and uploading checklist records to a data management system) and Data Transfer (for transfer of autosequence test record files to a data management system). A complete list of medTester 5000C modules is included in Chapter 1, *General Information*.

Related information can be found in:

- Chapter 5, *Autosequences*
- Chapter 6, *Customize Your medTester 5000C*
- Chapter 8, *Memory*
- Chapter 11, *medCheck*
- Chapter 12, *Remote Operation*
- IV pump tester operator's manual

To discover if you have the IV Pump module installed on your medTester 5000C, enter these menu commands from the medTester 5000C main menu, MENU 1, to access the autosequence menu:

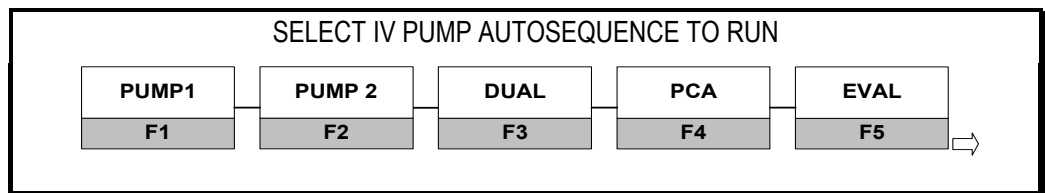


If the IV Pump module has not been installed, this message appears on the display:

**MODULE NOT INSTALLED**

If the module was installed and you get this message, it may be necessary to re-enable the module. Refer to the “Enabling Modules” section of Chapter 2 – Installation.

If IV pump autosequences are installed, you should see this message on the display:



The above display format and testing protocol is formatted for the Infutest 2000 Series D IV Pump Analyzer. If you wish to use one of the other IV pump analyzers, go to the following section of this chapter “Customizing IV Pump Test-Configuring for your IV Pump Analyzer”.

These autosequences are preprogrammed but can be customized. The arrow at the right side of the display tells you to press the right arrow to access the remaining five autosequences. These five are labeled as blank autosequences because they are intended for you to customize.

## IV Pump Autosequence Names

Begin any of the autosequences below by using the medTester menu commands or by typing the keyboard shortcut command.

IV Pump Autosequences for Infutest Series 2000 D						
Autosequence Name (Type of Test)	Keyboard Shortcut Command	Menu Commands from				
		<table border="1" style="margin: auto;"> <tr> <td style="text-align: center;">AUTO</td> <td style="text-align: center;">IVPUMP</td> </tr> <tr> <td style="text-align: center;">F1</td> <td style="text-align: center;">F3</td> </tr> </table> <p style="text-align: center;">MENU 1</p>	AUTO	IVPUMP	F1	F3
AUTO	IVPUMP					
F1	F3					
PUMP1	A50	<table border="1" style="margin: auto;"> <tr> <td style="text-align: center;">PUMP 1</td> </tr> <tr> <td style="text-align: center;">F1</td> </tr> </table>	PUMP 1	F1		
PUMP 1						
F1						
PUMP2	A51	<table border="1" style="margin: auto;"> <tr> <td style="text-align: center;">PUMP 2</td> </tr> <tr> <td style="text-align: center;">F2</td> </tr> </table>	PUMP 2	F2		
PUMP 2						
F2						
DUAL	A52	<table border="1" style="margin: auto;"> <tr> <td style="text-align: center;">DUAL</td> </tr> <tr> <td style="text-align: center;">F3</td> </tr> </table>	DUAL	F3		
DUAL						
F3						
PCA	A53	<table border="1" style="margin: auto;"> <tr> <td style="text-align: center;">PCA</td> </tr> <tr> <td style="text-align: center;">F4</td> </tr> </table>	PCA	F4		
PCA						
F4						
EVAL	A54	<table border="1" style="margin: auto;"> <tr> <td style="text-align: center;">EVAL</td> </tr> <tr> <td style="text-align: center;">F5</td> </tr> </table>	EVAL	F5		
EVAL						
F5						
		<p style="text-align: center;">Menu Command MENU 2</p>				
blank (user-defined)	A55-A59	<table border="1" style="margin: auto;"> <tr> <td style="text-align: center;">blank</td> </tr> <tr> <td style="text-align: center;">F1-F5</td> </tr> </table>	blank	F1-F5		
blank						
F1-F5						

IV Pump Autosequences for IPT-1						
Autosequence Name (Type of Test)	Keyboard Shortcut Command	Menu Commands				
		from				
		<table border="1"> <tr> <td>AUTO</td> <td>IVPUMP</td> </tr> <tr> <td>F1</td> <td>F3</td> </tr> </table>	AUTO	IVPUMP	F1	F3
AUTO	IVPUMP					
F1	F3					
		MENU 1				
LINEAR	A50	<table border="1"> <tr> <td>LINEAR</td> </tr> <tr> <td>F1</td> </tr> </table>	LINEAR	F1		
LINEAR						
F1						
PULSED	A51	<table border="1"> <tr> <td>PULSED</td> </tr> <tr> <td>F2</td> </tr> </table>	PULSED	F2		
PULSED						
F2						
LOW	A52	<table border="1"> <tr> <td>LOW</td> </tr> <tr> <td>F3</td> </tr> </table>	LOW	F3		
LOW						
F3						
HIGH	A53	<table border="1"> <tr> <td>HIGH</td> </tr> <tr> <td>F4</td> </tr> </table>	HIGH	F4		
HIGH						
F4						
EVAL	A54	<table border="1"> <tr> <td>EVAL</td> </tr> <tr> <td>F5</td> </tr> </table>	EVAL	F5		
EVAL						
F5						
		Menu Command MENU 2				
blank (user-defined)	A55-A59	<table border="1"> <tr> <td>blank</td> </tr> <tr> <td>F1-F5</td> </tr> </table>	blank	F1-F5		
blank						
F1-F5						



IV Pump Autosequences for IPT-MC				
Autosequence Name (Type of Test)	Keyboard Shortcut Command	Menu Commands from		
		<table border="1" style="margin: auto;"> <tr> <td style="text-align: center;">AUTO</td> <td style="text-align: center;">IVPUMP</td> </tr> <tr> <td style="text-align: center;">F1</td> <td style="text-align: center;">F3</td> </tr> </table>	AUTO	IVPUMP
AUTO	IVPUMP			
F1	F3			
MENU 1				
PUMP1	A50	<table border="1" style="margin: auto;"> <tr> <td style="text-align: center;">PUMP 1</td> </tr> <tr> <td style="text-align: center;">F1</td> </tr> </table>	PUMP 1	F1
PUMP 1				
F1				
PUMP2	A51	<table border="1" style="margin: auto;"> <tr> <td style="text-align: center;">PUMP 2</td> </tr> <tr> <td style="text-align: center;">F2</td> </tr> </table>	PUMP 2	F2
PUMP 2				
F2				
LOW	A52	<table border="1" style="margin: auto;"> <tr> <td style="text-align: center;">LOW</td> </tr> <tr> <td style="text-align: center;">F3</td> </tr> </table>	LOW	F3
LOW				
F3				
HIGH	A53	<table border="1" style="margin: auto;"> <tr> <td style="text-align: center;">HIGH</td> </tr> <tr> <td style="text-align: center;">F4</td> </tr> </table>	HIGH	F4
HIGH				
F4				
EVAL	A54	<table border="1" style="margin: auto;"> <tr> <td style="text-align: center;">EVAL</td> </tr> <tr> <td style="text-align: center;">F5</td> </tr> </table>	EVAL	F5
EVAL				
F5				
		Menu Command MENU 2		
blank (user-defined)	A55-A59	<table border="1" style="margin: auto;"> <tr> <td style="text-align: center;">blank</td> </tr> <tr> <td style="text-align: center;">F1-F5</td> </tr> </table>	blank	F1-F5
blank				
F1-F5				

## Running IV Pump Autosequences

To begin running IV pump autosequence tests, connect your medTester 5000C to your IV pump tester with the serial cable through the COM2 port on the medTester and the RS-232 serial port on the IV pump tester.

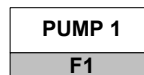
### Note

Refer to Chapter 1, *General Information – Accessories*, or the current Fluke Biomedical Price List for the correct serial cable part number needed.

Each preprogrammed IV pump autosequence has at least one step, and each step includes a flow rate test and a pressure (occlusion) test. The medTester 5000C displays measurements communicated to it by the IV pump analyzer. During the autosequence, the test receptacle on the medTester 5000C is always powered on normally, so you can power the EUT from it.

### Select the Autosequence

Begin by selecting the autosequence:



### Pretest Device Prompts

After you select this autosequence, you see the pretest prompts. There are eight prompts for information that can include in your test records. If you have some or all prompts turned off, the autosequence still gives you the opportunity to enter device information with the message:

Press F5 for all device info prompts

1. OP CODE—This is the operator code for the person doing the testing. This code can consist of a maximum of three characters which can be entered from the medTester keyboard. An example of an operator code could be a person's initials or employee number. The previous operator's code, if any, will appear. If the current operator has not changed from previous use, press the ENT key.
2. TYPE—Enter the device name, code, or other descriptor for the equipment under test. This entry can be a maximum of 16 characters.
3. MANF—Enter the name of the device manufacturer, 16 characters maximum.
4. LOC—Type in the location of the device, 16 characters maximum. The previous location, if any, will appear. If this occurs and is the desired location, press the ENT key.
5. MODEL—Enter the device model number, 16 characters maximum.
6. SERIAL #—Type the device serial number, again 16 characters maximum.
7. CONTROL #—Enter a control number with a maximum of 16 characters.
8. PHYSICAL INSPECTION—You have two physical inspection lines, each of which can consist of a maximum of 40 characters. After entering data for the first prompt, the second prompt appears.

**Note**

See Chapter 5, *Autosequences*, for a complete explanation of working with prompts. You can turn individual prompts on or off and rename the prompts numbered six through eight (6-8) above. Chapter 6, *Customize Your medTester 5000C*, explains how to customize prompts.

## IV PUMP TESTS

After you respond to prompts, the autosequence tests begin. For each step in the autosequence, the medTester will run a flow test and then an optional pressure test. The flow tests will be different depending on which IV pump analyzer is being used and which flow test type is selected:

### Infutest 2000 Series D

- On entering the test steps, the medTester checks that the Infutest is connected. If the Infutest is not detected, you must correct the fault and press F3 REPEAT to continue the test. Or for demonstrations, you can press F4 DUMMY to go through the autosequence without an IV Pump analyzer connected (press DOWN ARROW to continue when no other menus are active). Or you can press F5 EXIT to quit the autosequence.
- For each test step, the medTester prompts you with the test type and conditions. Press F5 NEXT to continue.
- Next, the medTester prompts you to make sure the Infutest is primed. Press F5 START to initiate the test. The Infutest SynchroStart feature waits for the IV Pump to actually begin delivering fluid to synchronize the test start. Start the IV Pump and wait for the Infutest to initiate the test and for the medTester to indicate that the test is running.

### Single Rate Test

- For a single rate test, the medTester displays the elapsed time (ET=), the remaining time (RT=) for a timed test, the remaining volume (RV=) for a volume ended test, the average flow rate ( $\Lambda$ =), the instantaneous flow rate (I=), and the cumulative volume (V=).
- After 5 minutes, the medTester checks each average flow rate value with the programmed limits. If the average flow rate is outside the limits, it is displayed with a '#'.
- You can wait for the test to end automatically, if it is a timed or volume ended test, or you can end the test by pressing F5 END.
- At the end of the test, the medTester again checks the average flow rate with the programmed limits. If the average flow rate is outside the limits, it is displayed with a '#' with the opportunity offered to continue or repeat the flow test.
- The medTester displays the final flow rate test results. Press F5 NEXT. Then you can repeat the test or continue on to the pressure test.

**Dual Rate Test**

- The dual rate test measures the delivery of two sequential fluid volumes pumped at different flow rates by the IV pump. This fluid delivery technique is typically referred to as “piggybacking” in the clinical environment. The dual rate test is conducted using the low flow rate range of the Infutest 2000 Series D IV pump analyzer only. In this low range, average flow rate measurements are restricted to 170 ml/hr with peak (or instantaneous) flow rate measurements limited to 200 ml/hr. Additionally, the initial higher fluid delivery (“Secondary”) must be five times (5:1) the following lower (“Primary”) flow rate and must minimally consist of 1.0 ml measured IV fluid.
- In a dual rate test, the medTester starts testing the secondary rate, indicated by “SEC” in the upper right corner of the display. It displays the elapsed time (ET=), the average flow rate (A=), the instantaneous flow rate (I=), and the cumulative volume (V=).
- After 5 minutes, the medTester checks each average flow rate value with the programmed limits for the secondary rate. If the average flow rate is outside the limits, it is displayed with a ‘#’.
- The test cannot end during the secondary rate. It must continue to the primary rate to successfully finish.
- When the IV pump rate changes to the primary rate, the Infutest detects the change and notifies the medTester. Then the medTester indicates “PRI” in the upper right corner. It displays the test parameters as before and also displays the remaining time (RT=) for a timed test or the remaining volume (RV=) for a volume ended test.
- And as before, the medTester checks each average flow rate value with the programmed limits, this time for the primary rate. If the average flow rate is outside the limits, it is displayed with a ‘#’.
- Now that the primary rate is running, you can wait for the test to end automatically, if it is a timed or volume ended test, or you can end the test by pressing F5 END.
- At the end of the test, the medTester again checks both the average flow rates with the programmed limits. If either average flow rate is outside the limits, it is displayed with a ‘#’ with the opportunity offered to continue or repeat the flow test.

- The medTester displays test results on 3 screens. Press F5 NEXT to go to the next screen. Finally, you can repeat the test or continue on to the pressure test.

### **PCA Test**

- The PCA (patient controlled analgesia) test measures the delivered IV fluid boluses administered by the patient using the PCA IV Pump handheld pushbutton control. It will also measure the lockout time between boluses and will compute the average lockout time at the completion of the test.
- The Infutest 2000 Series D will measure delivered bolus volumes  $\geq 0.5$  ml with no basal (or background) fluid flow. It is recommended not to use the initial “LOADING” medication dose function on the PCA IV Pump. If you desire to use this function, select “LOADING” medication dose volume equal to the programmed bolus volume. Just note that the final delivered bolus count computed by the Infutest & medTester 5000C should be one count higher than the displayed value on the PCA IV Pump. The PCA IV Pump will automatically deliver boluses when interfaced to the Infutest using optional PCA trigger cables.
- While measuring a bolus, the medTester displays “BOL=n” in the upper right corner, where n is the bolus number. It also displays the elapsed time (ET=), the remaining time (RT=), the average flow rate (A=), the instantaneous flow rate (I=), and the cumulative volume (V=) of the current bolus.
- The Infutest detects when the bolus is finished and notifies the medTester. Now it measures the lockout time. The Infutest continuously requests a new bolus from the IV pump. When the lockout time is finished, the IV pump starts a new bolus as soon as it triggered. The Infutest detects the new bolus. During the lockout time, the medTester displays the lock out time.
- You can wait for the test to end automatically when the remaining time expires or you can end the test by pressing F5 END.
- At the end of the test, the medTester checks the average bolus volume with the programmed limits. If the average bolus volume is outside the limits, it is displayed with a ‘#’ with the opportunity offered to continue or repeat the flow test.
- The medTester displays test results on 2 screens. Press F5 NEXT to go to the next screen. Finally, you can repeat the test or continue on to the pressure test.

### **IPT-1**

- With the IPT-1, you can perform 2 types of flow tests: steady flow and high accuracy. Use the steady flow selection to measure linear or continuous flow profiles and the high accuracy flow selection to measure pulsatile flow profiles or when a larger sample volume (~1 ml) is desired to be used for flow rate computation. Data from both types of flow tests are processed identically by the medTester.
- For each test step, the medTester prompts you with the test type and conditions. Press F5 NEXT to continue.
- Next, the medTester prompts you to prime the IPT-1. It must be primed or it cannot start a test. The IPT-1 displays “SEL” when it is primed. It needs to be primed at the beginning of each test. You should start the IV pump running at the desired flow rate before starting the test by pressing F5 START.
- The medTester displays the elapsed time (ET=), the remaining time (RT=) for a timed test, the remaining volume (RV=) for a volume ended test, the average flow rate (A=), the instantaneous flow rate (I=), and the cumulative volume (V=).
- After 5 minutes, the medTester checks each average flow rate value with the programmed limits. If the average flow rate is outside the limits, it is displayed with a ‘#’.
- You can wait for the test to end automatically, if it is a timed or volume ended test, or you can end the test by pressing F5 END.
- At the end of the test, the medTester again checks the average flow rate with the programmed limits. If the average flow rate is outside the limits, it is displayed with a ‘#’ with the opportunity offered to continue or repeat the flow test.
- The medTester displays the end of test results. Press F5 NEXT. Then you can repeat the test or continue on to the pressure test.

### **IPT-MC**

- On entering the test steps, the medTester checks that the IPT-MC is connected. If the IPT-MC is not detected, you must correct the fault and press F3 REPEAT to continue the test. Or for demonstrations, you can press F4 DUMMY to go through the autosequence without an analyzer connected (press DOWN ARROW to continue when no other menus are active). Or you can press F5 EXIT to quit the autosequence.

- For each test step, the medTester prompts you with the test type and conditions. Press F5 NEXT to continue.
- Next, the medTester prompts you to prime the IPT-MC. It must be primed or it cannot start a test. The IPT-MC displays “START” when it is primed. Usually it needs to be primed at the beginning of each test. You should start the IV pump running at the desired flow rate before starting the test by pressing F5 START. If the test does not start, you can again prime the IPT-MC and press F5 START.
- The medTester displays the elapsed time (ET=), the remaining time (RT=) for a timed test, the remaining volume (RV=) for a volume ended test, the average flow rate (AVG=), and the cumulative volume (VOL=).
- After 5 minutes, the medTester checks each average flow rate value with the programmed limits. If the average flow rate is outside the limits, it is displayed with a ‘#’.
- You can wait for the test to end automatically, if it is a timed or volume ended test, or you can end the test by pressing F5 END.
- At the end of the test, the medTester again checks the average flow rate with the programmed limits. If the average flow rate is outside the limits, it is displayed with a ‘#’ with the opportunity offered to continue or repeat the flow test.
- The medTester displays the end of test results. Press F5 NEXT. Then you can repeat the test or continue on to the pressure test.

#### **IDA 4 Plus**

- On entering the autosequence test steps, the medTester 5000C checks that the IDA 4 Plus is connected and ready. If the IDA 4 Plus is not detected, you must correct the fault and press F3 REPEAT to continue (repeat) the serial communication test. Or for demonstrations, you can press F4 DUMMY to go through the autosequence without an analyzer connected (press DOWN ARROW to continue when no other menus are active). Or you can press F5 EXIT to quit the autosequence.
- When the medTester 5000C displays the Step Introduction screen, press **F5 (NEXT)** to continue.
- Next the medTester 5000C displays PRIME IDA 4P TO "START".



- Wait for the IDA 4 Plus to display **PRIME** on channel 1. Using a priming syringe, prime IV line into IDA 4 Plus until the IDA 4 Plus displays
- After pressing **F5 (START)**, the medTester 5000C displays **START FLOW FOR IDA 4P AUTO-START**.
- Next the IDA 4 Plus displays **AUTO** and waits for the flow to start. After starting the flow on the IV Pump, the IDA 4 Plus should display **FLOW** followed shortly by flow data.
- If the IDA 4 Plus displays **ERROR** during a test, it is likely that a bubble was detected in the line, and the test is invalid. End the test, and repeat it.

### **Single Rate Test**

- For a single rate test, the medTester displays the elapsed time (ET=), the remaining time (RT=) for a timed test, the remaining volume (RV=) for a volume ended test, the average flow rate (A=), the instantaneous flow rate (I=), and the cumulative volume (V=).
- After 5 minutes, the medTester checks each average flow rate value with the programmed limits. If the average flow rate is outside the limits, it is displayed with a '#’.
- You can wait for the test to end automatically, if it is a timed or volume ended test, or you can end the test by pressing **F5 END**.
- At the end of the test, the medTester again checks the average flow rate with the programmed limits. If the average flow rate is outside the limits, it is displayed with a '#’ with the opportunity offered to continue or repeat the flow test.
- The medTester displays the final flow rate test results. Press **F5 NEXT**. Then you can repeat the test or continue on to the pressure test, if selected.

### **Dual Rate Test**

- The dual rate test measures the delivery of two sequential fluid volumes pumped at different flow rates by the IV pump. This fluid delivery technique is typically referred to as “piggybacking” in the clinical environment. **NOTE:** the initial higher fluid delivery (“Secondary”) must be five times (5:1) the following lower (“Primary”) flow rate and must minimally consist of 1.0 ml measured IV fluid

- In a dual rate test, the medTester starts testing the secondary rate, indicated by “SEC” in the upper right corner of the display. It displays the elapsed time (ET=), the average flow rate (A=), and the cumulative volume (V=).
- After 5 minutes, the medTester checks each average flow rate value with the programmed limits for the secondary rate. If the average flow rate is outside the limits, it is displayed with a ‘#’.
- The test cannot end during the secondary rate. It must continue to the primary rate to successfully finish.
- When the IV pump rate changes to the primary rate, the IDA 4 Plus detects the change and notifies the medTester. Then the medTester indicates “PRI” in the upper right corner. It displays the test parameters as before and also displays the remaining time (RT=) for a timed test or the remaining volume (RV=) for a volume ended test.
- And as before, the medTester checks each average flow rate value with the programmed limits, this time for the primary rate. If the average flow rate is outside the limits, it is displayed with a ‘#’.
- Now that the primary rate is running, you can wait for the test to end automatically, if it is a timed or volume ended test, or you can end the test by pressing F5 END.
- At the end of the test, the medTester again checks both the average flow rates with the programmed limits. If either average flow rate is outside the limits, it is displayed with a ‘#’ with the opportunity offered to continue or repeat the flow test.
- The medTester displays test results on 3 screens. Press F5 NEXT to go to the next screen. Finally, you can repeat the test or continue on to the pressure test.

### **PCA Test**

- The PCA (patient controlled analgesia) test measures the delivered IV fluid boluses administered by the patient using the PCA IV Pump handheld pushbutton control. It will also measure the lockout time between boluses and will compute the average lockout time at the completion of the test.

- The IDA 4 Plus will measure delivered bolus volumes  $\geq 0.5$  ml with no basal (or background) fluid flow. It is recommended not to use the initial “LOADING” medication dose function on the PCA IV Pump. If you desire to use this function, select “LOADING” medication dose volume equal to the programmed bolus volume. Just note that the final delivered bolus count computed by the IDA 4 Plus & medTester 5000C should be one count higher than the displayed value on the PCA IV Pump. The PCA IV Pump will automatically deliver boluses when interfaced to the IDA 4 Plus using optional PCA trigger cables.
- The medTester prompts you to prime the IDA 4 Plus. It must be primed or it cannot start a test. The IDA 4 Plus displays “START” when it is primed. Usually it needs to be primed at the beginning of each test. You should start the IV pump running at the desired flow rate before starting the medTester test by pressing F5 START. If the test does not start, you can again prime the IDA 4 Plus and press F5 START on the medTester.
- While measuring a bolus, the medTester displays “BOL=n” in the upper right corner, where n is the bolus number. It also displays the elapsed time (ET=), the remaining time (RT=), the average flow rate (A=), and the cumulative volume (V=) of the current bolus.
- The IDA 4 Plus detects when the bolus is finished and notifies the medTester. Now it measures the lockout time. The IDA 4 Plus’ optional PCS trigger box continuously requests a new bolus from the IV pump. When the lockout time is finished, the IV pump starts a new bolus as soon as it triggered. The IDA 4 Plus detects the new bolus. During the lockout time, the medTester displays the lock out time.
- You can wait for the test to end automatically when the remaining time expires or you can end the test by pressing F5 END.
- At the end of the test, the medTester checks the average bolus volume with the programmed limits. If the average bolus volume is outside the limits, it is displayed with a ‘#’ with the opportunity offered to continue or repeat the flow test.
- The medTester displays test results on 2 screens. Press F5 NEXT to go to the next screen. Finally, you can repeat the test or continue on to the pressure test if selected.
- To test lockout during a PCA test, connect the PCA Trigger Interface Box to the IDA 4 Plus, according to instructions in the IDA 4 Plus Operators Manual and Application Note, “PCA Trigger Interface Box for IDA 4 Plus”.

### Pressure Test (Infutest, IPT-1, IPT-MC and IDA 4 Plus)

- After completing the flow test, the autosequence continues by offering to perform a pressure test. The pressure test measures the peak occlusion pressure and the elapsed time to reach the peak. Press F1 YES to run the pressure test or F2 NO to skip it and go to the next flow test step.
- The pressure test runs the same for all IV pump analyzers. The IV pump analyzer must be primed in the same manner as for the flow test. Then press F5 START to start the pressure test.
- The IV pump analyzer occludes (blocks) the IV line, measures the pressure developed and notifies the medTester. The medTester displays the pressure (PRESSURE=) in psi (pounds per square inch) and mmhg (millimeters of mercury). The medTester keeps track of the peak pressure, which is the highest pressure encountered during the test, and displays it (PK=) also in PSI and mmHg. The medTester also displays the elapsed time (ET=).
- Allow the test to run long enough for the IV pump to sense the occlusion, alarm, and to shut off, and for the pressure to decrease below the peak. Press F5 END to finish the pressure test.
- The final display gives you the peak pressure level. The @ sign (with a time reading) indicates the time when the peak pressure was reached.
- You can repeat the pressure test by pressing F4. To continue with the next step in this autosequence, press F5.

#### Note

The remaining steps in this and other IV pump autosequences follow the same sequence described here. Consult the table *IV Pump Autosequence Tests* to see the steps in each autosequence. At the end of the last step, the medTester 5000C proceeds to the posttest prompts.

### Posttest Prompts

When all tests are completed with all Posttest prompts turned on, the medTester 5000C prompts you for:

1. COMMENTS
2. NEXT TEST DUE DATE
3. USER TIME **Computerized Maintenance Management Software (CMMS) users:** User time is required.
4. PRINT TEST TAG?
5. STORE and/or PRINT TEST RECORD

INFUTEST 2000 Series D AUTOSEQUENCE TESTS

Nominal Flow Rate (ml per hour)	Test Type	High Limit (ml per hour)	Low Limit (ml per hour)	End Type (manual, volume, or timed)	Ending Quantity <i>If Applicable</i> (ml for volume or hours:minutes for timed)
<b>Autosequence Name (Test Type): PUMP 1 Keyboard Shortcut Command: A50</b>					
60.0	Single Rate	66.0	54.0	Volume	5.0
120.0	Single Rate	132.0	108.0	Volume	10.0
240	Single Rate	264.0	216.0	Volume	20.0
<b>Autosequence Name (Test Type): PUMP 2 Keyboard Shortcut Command: A51</b>					
30.0	Single Rate	35.0	25.0	Volume	3.0
60.0	Single Rate	66.0	54.0	Volume	5.0
120.0	Single Rate	132.0	108.0	Volume	10.0
240.0	Single Test	264.0	216.0	Volume	20.0
<b>Autosequence Name (Test Type): DUAL Keyboard Shortcut Command: A52</b>					
Secondary 120.0 Primary 20.0	Dual Rate	132.0 25.0	108.0 15.0	Manual	
<b>Autosequence Name (Test Type): PCA Keyboard Shortcut Command: A53</b>					
Bolus Volume 1.0ml Lockout Time 30.00(mm:ss)	PCA	1.30ml	.70ml	Timed	03.00
<b>Autosequence Name (Test Type): EVAL Keyboard Shortcut Command: A54</b>					
5.0	Single Rate	5.9	4.1	Volume	1.5
10.0	Single Rate	11.0	9.0	Volume	2.5
20.0	Single Rate	22.0	18.0	Volume	2.5
30.0	Single Rate	33.0	27.0	Volume	2.5
60.0	Single Rate	66.0	54.0	Volume	5.0
120.0	Single Rate	132.0	108.0	Volume	10.0
240.0	Single Rate	264.0	216.0	Volume	30.0
480.0	Single Rate	528.0	432.0	Volume	60.0

IPT-1 AUTOSEQUENCE TESTS

Nominal Flow Rate (ml per hour)	Test Type	High Limit (ml per hour)	Low Limit (ml per hour)	End Type (manual, volume, or timed)	Ending Quantity <i>If Applicable</i> (ml for volume or hours:minutes for timed)
<b>Autosequence Name (Test Type): LINEAR Keyboard Shortcut Command: A50</b>					
60.0	Steady Flow	66.0	54.0	Volume	5.0
120.0	Steady Flow	132.0	108.0	Volume	10.0
240	Steady Flow	264.0	216.0	Volume	20.0
<b>Autosequence Name (Test Type): PULSED Keyboard Shortcut Command: A51</b>					
60.0	High Accuracy	66.0	54.0	Volume	5.0
120.0	High Accuracy	132.0	108.0	Volume	10.0
120.0	High Accuracy	132.0	108.0	Volume	10.0
<b>Autosequence Name (Test Type): LOW Keyboard Shortcut Command: A52</b>					
10.0	Steady Flow	11.0	9.0	Timed	00:05
<b>Autosequence Name (Test Type): HIGH Keyboard Shortcut Command: A53</b>					
480.0	High Accuracy	504.0	456.0	Timed	00:05
<b>Autosequence Name (Test Type): EVAL Keyboard Shortcut Command: A54</b>					
5.0	Steady Flow	5.9	4.1	Volume	1.5
10.0	Steady Flow	11.0	9.0	Volume	2.5
20.0	High Accuracy	22.0	18.0	Volume	2.5
30.0	High Accuracy	33.0	27.0	Volume	2.5
60.0	High Accuracy	66.0	54.0	Volume	5.0
120.0	High Accuracy	132.0	108.0	Volume	10.0
240.0	High Accuracy	264.0	216.0	Volume	30.0
480.0	High Accuracy	528.0	432.0	Volume	60.0

*IPT-MC AUTOSEQUENCE TESTS*

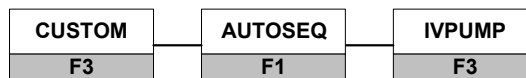
Nominal Flow Rate (ml per hour)	High Limit (ml per hour)	Low Limit (ml per hour)	End Type (manual, volume, or timed)	Ending Quantity <i>If Applicable</i> (ml for volume or hours:minutes for timed)
<b>Autosequence Name (Test Type): PUMP 1 Keyboard Shortcut Command: A50</b>				
60.0	66.0	54.0	Volume	5.0
120.0	132.0	108.0	Volume	10.0
240	264.0	216.0	Volume	20.0
<b>Autosequence Name (Test Type): PUMP 2 Keyboard Shortcut Command: A51</b>				
30.0	35.0	25.0	Volume	3.0
60.0	66.0	54.0	Volume	5.0
120.0	132.0	108.0	Volume	10.0
120.0	132.0	108.0	Volume	10.0
<b>Autosequence Name (Test Type): LOW Keyboard Shortcut Command: A52</b>				
10.0	11.0	9.0	Timed	00:05
<b>Autosequence Name (Test Type): HIGH Keyboard Shortcut Command: A53</b>				
480.0	504.0	456.0	Timed	00:05
<b>Autosequence Name (Test Type): EVAL Keyboard Shortcut Command: A54</b>				
5.0	5.9	4.1	Volume	1.5
10.0	11.0	9.0	Volume	2.5
20.0	22.0	18.0	Volume	2.5
30.0	33.0	27.0	Volume	2.5
60.0	66.0	54.0	Volume	5.0
120.0	132.0	108.0	Volume	10.0
240.0	264.0	216.0	Volume	30.0
480.0	528.0	432.0	Volume	60.0
240.0	264.0	216.0	Volume	30.0
480.0	528.0	432.0	Volume	60.0

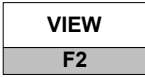
## Customizing IV Pump Tests

(For detailed information about customizing autosequences, please refer to Chapter 6, *Customize Your medTester 5000C*.)

To begin customizing IV pump autosequences, you can view any of your current ones by entering these menu commands:

1. From the main menu, MENU1, press the right arrow to access MENU2.
2. Enter the menu commands:



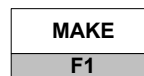
3. From the IVPUMP menu, select: 
4. Now select the IV pump autosequence you want to view.
5. Finally scroll through the steps in the sequence by using your up and down arrow keys.

### Make Your Own Autosequence

You can customize the five preprogrammed IV pump autosequences or create five new ones with the blank sequences. This section describes the menu steps and order of steps that you use to customize, or create, autosequences. Note that each customized autosequence can include more than one step. After you complete item one below (name), the medTester 5000C prompts you for step one entries which begin with the flow tests described in number two below. You can have up to ten steps in each autosequence.

### Making an Autosequence

Begin by accessing the custom, autosequence, IVPUMP menu as described above. This time, select:



Next select the name of the autosequence you want to customize or create. Follow these steps, providing the desired information:



1. Name—This is the name you want to give to the autosequence, with a maximum of six characters.
2. Flow Tests—Up to 10 steps. The tests available are different for each of the IV pump analyzers:

### **Infutest**

For Infutest, there are 3 types of tests available. First select the test type, SINGLE, DUAL, or PCA:

#### **For a Single Rate Test:**

1. FLOW RATE: Enter the nominal flow rate, 0000.1 to 0999.0 ml/hr.
2. RATE HIGH LIMIT: Enter the high limit for the flow rate. 0000.0 turns off high limit checking.
3. RATE LOW LIMIT: Enter the low limit for the flow rate. 0000.0 turns off low limit checking.
4. TEST END TYPE: Select
  5. MANUAL to end the test by pressing a key.
  6. TIMED to end the test after a programmed time:
    7. END TIME: Enter the elapsed time that will end the test, 00:01 to 99:59 (hours:minutes).
  8. VOLUME to end the test after a specific volume.
    9. END VOLUME: Enter the volume that will end the test, 0000.1 to 9999.0 ml.

#### **For a Dual Rate Test:**

##### **NOTE:**

In a dual rate test, the first infusion, which is the faster rate is known as the secondary rate. The second infusion, which is the slower rate is known as the primary rate. The secondary rate must be at least 5 times faster than the primary rate. Since measurements use the low flow range on the Infutest, the maximum secondary rate is 170 ml/hr (average) or 200 ml/hr (peak-instantaneous). A minimum of 1.0 ml must be measured in the secondary rate test.

1. SECONDARY FLOW RATE: Enter the nominal flow rate, 0000.1 to 0999.0 ml/hr.

2. SECONDARY RATE HIGH LIMIT: Enter the high limit for the flow rate. 0000.0 turns off high limit checking.
3. SECONDARY RATE LOW LIMIT: Enter the low limit for the flow rate. 0000.0 turns off low limit checking.
4. PRIMARY FLOW RATE: Enter the nominal flow rate, 0000.1 to 0999.0 ml/hr.
5. PRIMARY RATE HIGH LIMIT: Enter the high limit for the flow rate. 0000.0 turns off high limit checking.
6. PRIMARY RATE LOW LIMIT: Enter the low limit for the flow rate. 0000.0 turns off low limit checking.
7. TEST END TYPE: Select
  8. MANUAL to end the test by pressing a key.
  9. TIMED to end the test after a specific time:
    10. END TIME: Enter the elapsed time that will end the test, 00:01 to 99:59 (hours:minutes).
  11. VOLUME to end the test after a specific volume:
    12. END VOLUME: Enter the volume that will end the test, 0000.1 to 9999.0 ml.

**For a PCA Test:**

- BOLUS VOLUME: Enter the bolus volume, 00.50 to 99.99 ml.
  - BOLUS VOLUME HIGH LIMIT: Enter the high limit for the bolus volume. 00.00 turns off high limit checking.
  - BOLUS VOLUME LOW LIMIT: Enter the low limit for the bolus volume. 00.00 turns off low limit checking.
- LOCKOUT TIME: Enter the lockout time between boluses, 00:01 to 99:99 (minutes:seconds).
  - END TIME: Enter the elapsed time that will end the test, 00:01 to 99:99 (hours:minutes).

**IPT-1**

For the IPT-1, there are 2 types of tests available, steady flow and high accuracy:

1. FLOW RATE: Enter the nominal flow rate, 0000.1 to 0999.0 ml/hr.
2. FLOW TEST TYPE: Enter STEADY for steady flow or HI ACC for high accuracy.
3. RATE HIGH LIMIT: Enter the high limit for the flow rate. 0000.0 turns off high limit checking.

4. RATE LOW LIMIT: Enter the low limit for the flow rate. 0000.0 turns off low limit checking.
5. TEST END TYPE: Select
  6. MANUAL to end the test by pressing a key.
  7. TIMED to end the test after a programmed time:
    8. END TIME: Enter the elapsed time that will end the test, 00:01 to 99:59 (hours:minutes).
  9. VOLUME to end the test after a specific volume.
    10. END VOLUME: Enter the volume that will end the test, 0000.1 to 9999.0 ml.

### **IPT-MC**

For the IPT-MC, there is only 1 type of test available, a regular flow test:

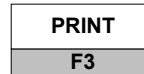
1. FLOW RATE: Enter the nominal flow rate, 0000.1 to 0999.0 ml/hr.
2. RATE HIGH LIMIT: Enter the high limit for the flow rate. 0000.0 turns off high limit checking.
3. RATE LOW LIMIT: Enter the low limit for the flow rate. 0000.0 turns off low limit checking.
4. TEST END TYPE: Select
  5. MANUAL to end the test by pressing a key.
  6. TIMED to end the test after a programmed time:
    7. END TIME: Enter the elapsed time that will end the test, 00:01 to 99:59 (hours:minutes).
  8. VOLUME to end the test after a specific volume.
    9. END VOLUME: Enter the volume that will end the test, 0000.1 to 9999.0 ml.

After completing these entries, for up to ten (10) steps, the medTester prompts you to store the autosequence:



### **Print Your Autosequence**

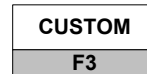
From the IV pump autosequences menu described above, printing any autosequence is accomplished through this menu command:



### Reinitialize Factory Default Settings

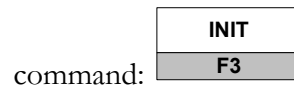
Any customized autosequences can be returned to the factory default settings. To do this, enter these medTester commands:

1. From the medTester 5000C main menu, MENU 1, press the right arrow to access MENU 2.

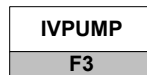


2. Enter the command:

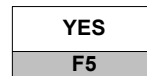
3. From the custom menu, press the right arrow and enter the



4. Choose:



5. To initialize IV pump autosequences to defaults, press:



#### NOTE:

All user programmed IV pump autosequences will be erased with this initialization.

Whenever the IV pump type designation is changed, you must initialize to notify the medTester to change the available tests to coincide with the test pump. Failure to initialize following a type change will result in erroneous results.

# Chapter 11

## medCheck Module

*In this chapter you will find information about checklists—what they are, how they are used, running them in the medTester 5000C, and reporting test record data.*

### Tap Your medTester's Potential

With the medCheck option installed in memory on your medTester 5000C, you can tap into the medTester's capability to become a total equipment management solution. With medCheck your medTester 5000C can automate electrical safety and performance testing for you. Using an Equipment Management System (EMS) or Computerized Maintenance Management System (CMMS), on a personal computer, you can write preventive maintenance checklists, download them to and execute them in your medTester 5000C, and upload the test records to your EMS or CMMS.

Combining checklists, medCheck and your CMMS lets you develop your overall equipment management system. In your CMMS, you set up accounts and equipment records. Each piece of equipment in your inventory receives a unique control number or asset ID. You then associate checklists (test procedures) with your equipment's control number, download the checklists to your medTester, run your checklists of tests, and finally upload test record data back to your CMMS. Whenever you have a piece of equipment without an assigned control number (e.g. a new piece of equipment), you can execute it and assign a valid or "temporary" control number that can be reassigned following upload to your CMMS.

With medCheck, your medTester can interface and control external equipment such as the Impulse 4000 Defibrillator Analyzer or the IDA 4 Plus Infusion Pump Tester. The medTester 5000C controls these devices through the appropriate serial cable on the medTester's COM1 or COM2 port or Wedge Adapter port and the RS-232 port on the Fluke Biomedical analyzer or tester. See the section *Remote Control of Fluke Biomedical Testers* at the end of this chapter.

**Note**

In order to use the medCheck Module, your medTester 5000C requires the installation of these modules:

- RS-232/Printer Module (2)
- 100 Record Memory Module (3)
- Expanded Memory Module (4)
- Data Transfer Module (6)

You can find a complete list of medTester 5000C modules, their descriptions, and requirements for use in Chapter 1, *General Information*.

## **What's a Checklist?**

A checklist is a list of instructions to the medTester and Technician that tells each which tests to run and in what order. The checklist could include setup, measurement, and wave commands (described later in this chapter). The list could include standard and user-configured autosequences (see Chapter 5, *Autosequences*). Or it could include instructional prompts to the operator to do something, for example, clean the Equipment Under Test (EUT) or plug the EUT into the test receptacle.

## Understanding and Using Checklists

Checklists let you standardize and quickly test equipment, accurately record the measurements, and manage all of this information for your reports. A good way to understand a checklist in medCheck is to look at how it can help you do your work. Below is an example checklist for a commonly used defibrillator. This defibrillator is connected to a Fluke Biomedical Impulse 4000 Defibrillator Analyzer. The Impulse 4000 in this example is, in turn, connected to a medTester 5000C through its COM2 port with a serial cable.

This example includes one safety autosequence performed on the EUT, physical and functional checks of the EUT, and a defibrillator autosequence.

### Note

This example illustrates the use of a checklist. It is not recommended for use on any specific equipment. **Always check the equipment manufacturer's maintenance recommendations for safety and performance testing of any equipment.**

**medTester  
Autosequence  
Number**

**Control Codes**  
(see explanations below)

- P*—Pass or Fail
- I*—Input requested.
- B*—Both P&I
- M*—medTester remote or pause command.
- A*—Autosequence

<b>ABC HOSPITAL</b>	
<b>Defibrillator Checklist</b>	
<b>Checkitem Description</b>	<b>Control Code</b>
A5	A
Chassis and housing...General condition	B
Battery and charger...Check operation	B
Fuses/circuit breakers...ratings OK?	B
Hardware...condition and integrity	B
Indicators and displays...operation	P
Controls and switches...check condition	P
Alarms and interlocks...check operation	P
Accessories...condition and operation	P
Mounts and fasteners...check condition	B
Cables and leads...check condition	B
Fittings and connectors...condition	B
Paddles...check condition	B
Chart recorder...	B
Chart speed...check at all settings	B
Stylus/pens...condition and pressure	B
Operation...overall function OK?	B
A46	A
Synchronization...sync with R-wave?	B
Synchronization time test...check	B
Maximum energy level test...output	B
Delivered energy after 10 maximum discharges	B
Internal discharge of stored energy	B
Battery life test...continued use	B
Refer to tech manuals for specifics	B
Labeling...all placards and labels	B
Attach dated and initialed PM tag	I



As you can see, some checkitems appear in the medTester as prompts to the operator to do something, for example, a physical inspection of the EUT or a check of some function. Other checkitems are autosequences. Autosequence 46 is a customized (user defined) autosequence that can execute a variety of performance tests on this defibrillator. For more information about defibrillator autosequences, see Chapter 9, *Defibrillator Module*. To learn more about customizing autosequences, see Chapter 6, *Customize Your medTester 5000C*.

This checklist could be downloaded to the medTester with a list of control numbers. Control numbers identify unique pieces of equipment. Each control number has a checklist assigned to it. When you perform the checklist on a control number-referenced piece of equipment, the test record that is generated includes the control number. If you test a defibrillator of this model type and it has no control number, the medTester can prompt you to assign one. This lets you bring new equipment into inventory as you test. Of course, you still have the option of making an equipment record and assigning a control number prior to testing it with the checklist.

In this example the last checkitem in the checklist prompts the operator to write out a preventive maintenance tag that is placed on the EUT after the checklist runs. The medTester 5000C also has an automated tag generation capability. This requires the connection of an optional test label printer. See the *Test Tag Printer* section in Chapter 5.

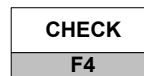
## You've Made a Checklist—Now What?

While the process of making a checklist takes place in your CMMS, using it takes place inside the medTester with the medCheck option. This begins with loading the checklist files into the medTester. There are three files that comprise a checklist and that your CMMS downloads to the medTester:

- **IDN File:** Containing equipment identification control numbers and the checklist names themselves, each associated with a checklist to run.
- **ITEM File:** Containing the checkitems that a checklist calls. A checkitem is a prompt of something to do or check, an autosequence, a medTester command, or a command that the medTester passes through to another instrument. These instruments can be controlled by the medTester 5000C through a serial cable attached to the medTester's COM2 or assigned Wedge port and the RS-232 port on the analyzer or tester.
- **LIST File:** Containing the checklists. Each checklist has a name and a list of checkitems to execute.

## Running Checklists in medTester 5000C

Running checklists in the medTester 5000C begins with the CHECK menu from MENU1. For this example, we want to work with control number **000001**. To discover if medCheck is installed on your medTester 5000C, enter these menu commands from the medTester 5000C main menu, MENU1, to access checklists:



If medCheck is not installed, this message appears on the display:

**MODULE NOT INSTALLED**

If the module was installed and you get this message, it may be necessary to re-enable the module. Refer to the “Enabling Modules” section of Chapter 2 – Installation.

If medCheck is installed, you see this message on the display:

**CHECKLIST: XXXXXX**

This message shows you that checklists have been loaded into the medTester 5000C. The characters XXXXXX take the place, in this example, of a control number.

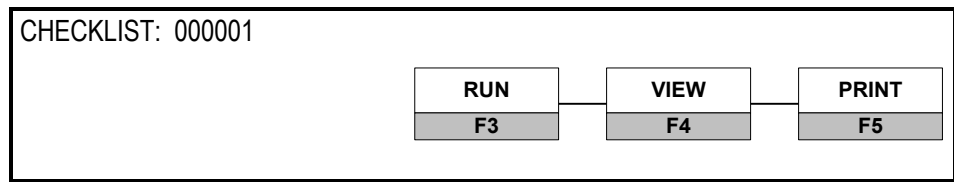
### Find a Checklist

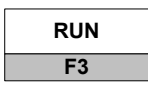
From the check menu, you can enter either a control number, which references a checklist name, or the name of the checklist you want from the IDN file. Type a partial control number, or name, or use the up or down arrow keys to search. After you find the desired checklist, press ENT.

Alternatively, type the entire control number or checklist name at the main menu to run a checklist.

### Run a Checklist

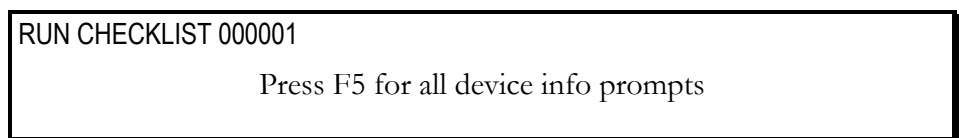
Once you select a checklist medTester displays:



Press  to run this checklist.

### What Happens When You Run A Checklist

If you select RUN from the display, this message appears:



### Pretest Device Prompts

There are eight prompts for information that you can attach to checklist records. If you have some or all prompts turned off, you still have the opportunity to enter device information. Checklist pretest prompts allow you to execute a checklist for a device with an assigned control number, or to assign a control number to a device for a checklist designed for that device.

- 1. OP CODE**—This is the operator code for the person doing the testing. This code can consist of a maximum of three characters which can be entered from the medTester keyboard. An example of an operator code could be a person's initials or employee number. The previous operator's code, if any, will appear. If the current operator has not changed from previous use, press the ENT key.
- 2. TYPE**—The name of the checklist that corresponds to the checklist number we have selected appears in this prompt. This entry can be a maximum of 16 characters.
- 3. MANF**—Enter the name of the device manufacturer, 16 characters maximum.
- 4. LOC**—Type in the location of the device, 16 characters maximum. The previous location, if any, will appear. If this occurs and is the desired location, press the ENT key.
- 5. MODEL**—Enter the device model number, 16 characters maximum.
- 6. SERIAL #**—Type the device serial number, again 16 characters maximum.
- 7. CONTROL #**—The selected control number or checklist name from the IDN file appears for this prompt. You can assign a control number here for a new device for which this checklist is written. Enter a control number with a maximum of 16 characters.
- 8. PHYSICAL INSPECTION**—You have two physical inspection lines, each of which can consist of a maximum of 40 characters. After entering data for the first prompt, the second prompt appears.

**Note**

Turning off pretest prompts for checklists helps save time in executing checklists on several pieces of equipment. After you have all equipment set up and connected, simply enter the control number for the EUT. If you want to run a checklist on a piece of equipment that has not been assigned a control number, press F5 to enter all device information—including a control number.

See Chapter 5, *Autosequences*, for a complete explanation of working with prompts. You can turn individual prompts on or off and rename prompt numbers six through eight (6-8) in the preceding list. Chapter 6, *Customize Your medTester 5000C*, explains how to customize prompts.

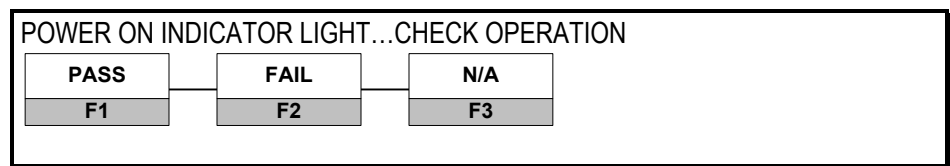
From this point, the medTester executes all checkitems, including autosequences and remote commands. The medTester may prompt you to perform specific tasks as part of the checklist, for example, turning the power on or off to the EUT. If an autosequence executes as part of the checklist, the medTester prompts you for comments at the end of that sequence.

**Items in a Checklist**

There are five different categories of checkitems that a checklist can contain:

**Pass/Fail (P) Category**

Pass or fail checkitems appear on the medTester 5000C display as checkitems that prompt you to do something. An example of this category of checkitem could be viewed on the medTester display as:



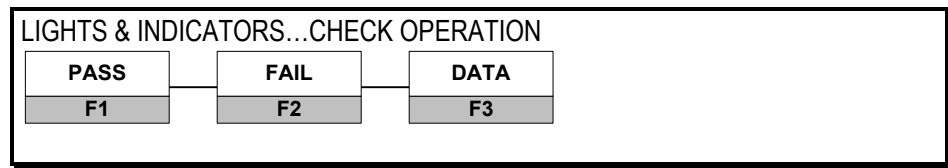
For this checkitem, if the indicator light is operational, press F1; if not press F2. If this device does not have a power-on indicator light, press F3 to show that the checkitem is not applicable for this device. A FAIL stores the character # in the checkitem record.

### Input Requested (I) Category

This checkitem tells the operator to check something or to do something and then input a comment or data. After responding to the prompt, press ENT to move to the next checkitem.

### Both P&I (B) Category

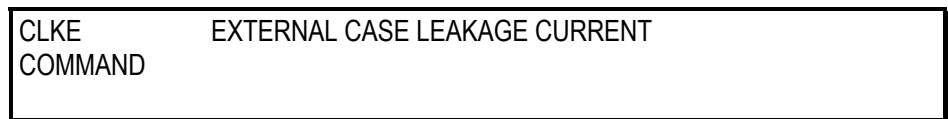
This checkitem combines both pass or fail and input. The operator enters either pass or fail (the result of that checkitem's test) or comments that the operator can input for that test.



A FAIL stores the character # in the checkitem record.

### Remote Command (M) Category

There are two sub-categories of remote commands—remote commands themselves and pause commands. You can insert remote commands as checkitems in a checklist. In this example (CLKE) the medTester sets up a measurement for case leakage current, external leads:



The message EXTERNAL CASE LEAKAGE CURRENT is a comment.

In addition, you can include a remote command that is sent through the medTester 5000C to a tester or analyzer (like the Impulse 4000 Defibrillator Analyzer) connected to the medTester's COM2 serial port. If the medTester 5000C does not recognize the command as one of its own, it considers it as an external command. The medTester passes these commands out the COM2 port to the tester or analyzer. The medTester automatically takes a reading from the analyzer, displays it, and stores it.

If an external remote command is followed by a number, the medTester 5000C waits that number of seconds for a response. Otherwise it waits five seconds.

If an external command is followed by the number 0, the medTester will not expect or look for a response from the external analyzer. It stores nothing in the test record for that checkitem.

**Note**

Remote commands begin with alphabetic characters. See *Remote Commands List* in Chapter 12, *Remote Operation*.

**Pause Command (M) Sub-Category**

You can also insert a checkitem in a checklist that simply creates a pause in the execution of the checklist. A pause command is any numeric string (1 to 32768) that inserts a pause for that number of seconds. Here's an example:

```
10 SECOND DELAY
PAUSE:                10 SECONDS REMAINING
```

The message SECOND DELAY is a comment. The seconds count down on the display before the checklist continues.

**medTester Autosequence (A) Sub-Category**

Autosequences are placed in a checklist with the insertion of the autosequence number. These numbers are listed by type—safety, defibrillator, IV pump—in their respective chapters in this manual. When the autosequence number appears in the checklist, the medTester 5000C executes that autosequence. When executed as part of a checklist, these autosequences do not prompt you for pretest information. Posttest prompts do appear. The medTester stores checklist autosequence data separate from the checklist record. Upon completion of the autosequence, the medTester returns to the remaining checkitems in the checklist.

**If You Make a Mistake**

During the execution of the checklist you may notice that you have made a mistake. For example, you could enter *pass* when you want to enter *fail* on the result of a test checkitem. In this case, the medTester 5000C allows you to back up in the checklist to a previous checkitem so that you can correct the error. To back up in the checklist, press the up arrow key. You can then rerun that checkitem.

With *M* (remote pause command) and *A* check items, you have two (2) seconds to back up in the checklist before the checkitem executes.

### Posttest Prompts

Posttest prompts that have been switched on appear upon completion of the checklist. After responding to any posttest prompts, the medTester asks you to store or print the test record.

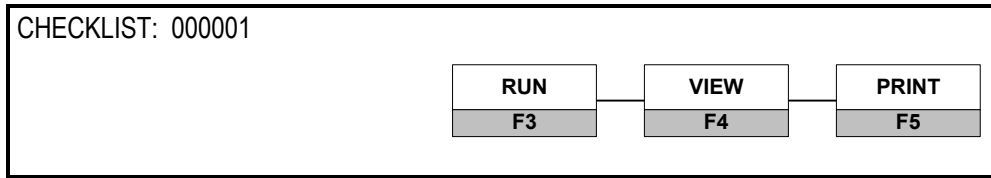
### Checklist Records

The number of checklist records that the medTester 5000C creates is dependent upon the structure of the checklist. One record is stored for the checklist itself. Individual records for autosequences executed as part of the checklist are generated separately. The checklist record itself is generated last. After you execute checklists that you have loaded into the medTester, you can upload the data recorded in memory to your EMS or CMMS. In addition, you can view or print records using the memory functions.

If *elapsed test time* is turned on, time is recorded for the entire checklist. If any autosequences are executed as part of the checklist, autosequence elapsed times are displayed as: XXX.

### View or Print a Checklist

You can view or print a checklist (**not** the test record) from the checklist menu using the same procedure described above for finding and running a checklist. Once you select a checklist medTester displays:



Press either VIEW or PRINT.

To view the selected checklist, choose VIEW from the CHECK menu. The example below displays how one checkitem appears when you view it:

A screenshot of a single checklist item displayed in a rectangular box. The text inside the box is: "ITEM: X TYPE: PASS/FAIL/DATA" on the first line, and "LIGHTS & INDICATORS...CHECK OPERATION" on the second line.

What you see is the number of the first ITEM in the checklist with its sequence number. Also the TYPE of checkitem appears. TYPE means the control type placed on the checkitem within the EMS or CMMS when you write the checklist.



## **Remote Control of Fluke Biomedical Testers**

You can have the medTester 5000C control other instruments, such as the Fluke Biomedical Impulse 4000 Defibrillator Analyzer or the IDA 4 Plus Infusion Pump Tester. The medTester 5000C controls these devices through a serial cable connected to the COM2 port on the medTester 5000C and the RS-232 port on the analyzer or tester. The defibrillator checklist example above uses the Fluke Biomedical Impulse 4000 Defibrillator Analyzer. For additional information about the communications capabilities of the medTester 5000C, see Chapter 12, *Remote Operation*.



# Chapter 12

## Remote Operation

*In this chapter you find information on both local and remote mode operation of the medTester 5000C. In addition, serial port configurations and communications are described, along with medTester file transfer protocol and remote medTester commands.*

### Local Versus Remote Mode

You can operate the medTester 5000C in two modes—local and remote. Local is the typical mode of operation whereby input can be from the keyboard, a bar code port, or a serial port. In local mode, you enter menu commands, checklist identification numbers or names, and information strings during menu operations or autosequences.

Remote mode, on the other hand, means that all medTester keys are disabled. In this mode, your only means of entering data into the medTester is through a serial port. Typically the operator is using a personal computer or a terminal to issue commands to the medTester. Commands you type appear on the medTester display. All executed commands in the medTester return output to the remote screen.

### Communicating through medTester Serial Ports

The medTester 5000C has two serial ports located on the back panel, COM1 and COM2.

#### COM1 COM2 Functions

- Input in Local Mode—for example, the Fluke Biomedical keyboard option, bar code scanning gun, or a personal computer or terminal.
- Output in Local Mode—for printing test records to a personal computer or compatible terminal device, or test tags to a serial printer.
- Two-way Communications—medTester control from a remote personal computer or a compatible terminal device.

### **Additional COM2 Functions**

Two-way Communications—for commands to and responses from Fluke Biomedical testers and analyzers and other instruments connected to this port and controlled through the medTester 5000C.

#### **Note**

You can expand COM2 with the Wedge adapter to a total of eight (8) ports. See Chapter 13, *The Wedge Adapter*.

### **Communications Settings**

Available baud rates are:

- 300
- 600
- 1200
- 2400
- 4800
- 9600
- 19200

You can configure the baud rate for each port independently.

Characters are transmitted at:

- 8 bits
- No parity
- 1 stop bit

Characters can be received with:

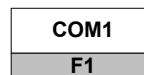
- 8 bits
- No parity
- 1 or more stop bits

#### **Setting Baud Rates**

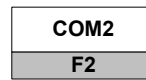
You can set baud rates for the serial ports from the main menu, MENU1. Press the right arrow to access MENU2. Enter the following commands:



COM1 baud rates are selected from:



COM2 baud rates are selected from:



**Note**

If you have enabled the Wedge adapter, there will be additional baud rate menus for COM2-1 through COM2-8. See Chapter 13, *The Wedge Adapter*.

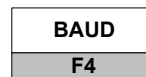
After selecting the desired port, the medTester displays the following message:



COM# refers to the number of the COM port that you select. The number 9600 refers to the current baud rate set for that port. This number varies depending upon which baud rate has previously been selected.

**Setting and Storing Baud Rates**

Set the baud rates for the desired port by pressing:



Notice how the baud rate displayed changes as you press this key. Once you select a baud rate, you can store the setting:



**Local Input Mode**

In local mode, a serial port can receive input characters. Characters received act as if they were typed in from the instrument keyboard, enabled in exactly the same way.

You can connect the optional RS-232 keyboard or laser bar code gun to either serial port. Input from this keyboard appears on the medTester display identical to the appearance of input displayed from the medTester 5000C keyboard. Hexadecimal codes for mimicking keystrokes are as follows. Any serial connecting device can send the codes with the same results:

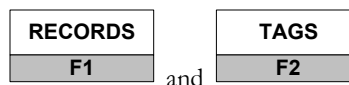
Hexadecimal Number to Enter	Corresponding medTester Key
80	F1
81	F2
82	F3
83	F4
84	F5
11	Cursor UP
14	Cursor DOWN
12	Cursor LEFT
13	Cursor RIGHT
1B	ESCAPE
0D—Carriage return (CR), or 0A—Line feed (LF)	ENTER
08	BACKSPACE
B0	INSERT
7F	DELETE
10 (Control-P)	PRINT
All ASCII alphanumeric and punctuation codes from 20 (space) to 7E (~).	
Note: In the case where strings are entered rapidly by computer, they may be terminated by both CR and LF.	

## Local Output for Records and Tags

In local mode, you can output test records, instrument settings, and test tags via COM1, COM2, or the printer port. To configure output for records or tags, once again use the utility menu:

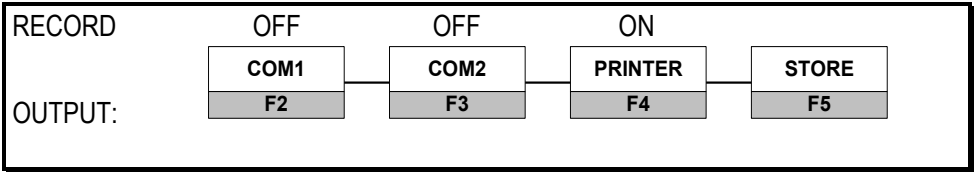


Menu choices displayed are:



**Record Output**

If you enter RECORDS, you see a display similar to this:



**Configuring Ports for Record Output**

Configure any of these three ports for output by pressing the desired port’s function key. Pressing the ports function key turns the port on or off. The display above shows that COM1 is off, COM2 is off, and the printer port is turned on for output. After configuring ports, press F5 to store your selections.

**Note**

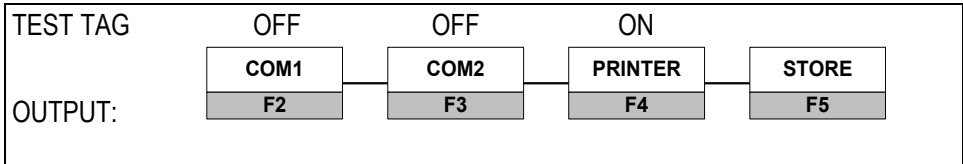
If you have enabled the Wedge adapter, you have additional COM2 choices, ON-1 through ON-8. See Chapter 13, *The Wedge Adapter*.

**Note**

Ports that you configure for record output are also active for all other print functions—autosequences, checklists, manual tests, etc., except test tags.

**Test Tag Output**

If you enter TAGS, you see a display similar to this:



### Configuring Ports for Test Tag Output

Configure any of these three ports for test tags as described above for record output. Press the port function keys to turn individual COM or printer ports on or off. Store your settings with the F5 key.

#### Note

If you have enabled the Wedge adapter, you have additional COM2 choices, ON-1 through ON-8. See Chapter 13, *The Wedge Adapter*.

## Remote Mode

You can control your medTester 5000C through a serial port by sending remote commands. Typically the operator is using a personal computer (or any terminal that allows transmission of ASCII characters) with a terminal emulation program, communications software program, or database program to issue commands to the medTester. When you enter the remote mode, all medTester keyboard input is disabled. Incoming remote commands to the medTester appear on the display, along with response messages.

### Going Remote

In order to remotely operate the medTester 5000C, ensure that you connect the correct serial cable from a serial port on the medTester to the correct serial communications port on your personal computer or terminal.

### Port Selection

To establish remote control of a single serial port at a time, type **remote**, or send **remote** as a command to a serial port. (Remote commands are not case sensitive). Port selection is established in this manner:

- If remote is received from a serial port, then that port is the remote port, otherwise...
- COM1 is selected the first time the medTester 5000C is operated remotely from a personal computer or terminal device.
- If the medTester 5000C has been operated remotely before, the last port receiving a remote command is selected for remote control.



**Forcing A Port**

An alternative to the above procedure is *forcing* a port. For example, if you want COM1 to be the remote port, type or send **remote1**. This will force COM1 to act as the remote port. To force COM2, type or send **remote2**.

If you have made a remote connection, the medTester responds by sending: **REMOTE MODE** out the remote serial port. At the same time, the medTester 5000C display becomes blank.

**Command Syntax Rules**

- Send commands in uppercase or lowercase letters.
- Spaces are ignored.
- Use the backspace character for editing.
- Terminate commands with a carriage return (CR), or line feed (LF), or both.
- Commands with an equal sign (=) require that at least one parameter be included with the command.
- Use commas to separate multiple parameters.

Complete lists of medTester 5000C remote commands and parameters are shown in the *Remote Commands List* section later in this chapter.

**Responses to Commands**

- Every command you issue to the medTester returns a response to the remote serial port.
- Responses return character strings, numbers, or data files.
- If no other response appears, an asterisk (\*) appears to indicate that the command has been executed.
- Previous commands must execute and return their responses before the medTester will accept further commands.
- The null command (consisting only of terminating characters) returns a question mark (?).
- Command responses are in uppercase letters followed by a carriage return and line feed.
- Measurement reading responses appear as they do on the medTester 5000C. Numbers may appear with or without a decimal point and are followed by the unit of measurement abbreviation. See the table that follows.

UNIT of MEASUREMENT ABBREVIATIONS	
Abbreviation	Unit of Measurement
V RMS	Volts RMS
A RMS	Amperes RMS
μA RMS	Microamperes RMS
μA DC	Microamperes DC
OHMS	Ohms
RPM	Revolutions per minute
DEG F	Degrees Fahrenheit
DEG C	Degrees Centigrade
%	Percent

### **Error Responses**

If you issue an incorrect or nonexistent remote command, the medTester responds with an error statement in this format: ERR=xx. Here is a list of possible error responses and explanations.

ERROR RESPONSES	
Error Statement	Explanation
ERR=01,UNKNOWN COMMAND	The received command was not recognized.
ERR=02,ILLEGAL COMMAND	The received command was not allowed for the current instrument status.
ERR=03,ILLEGAL PARAMETER	A parameter sent with a command was not the right type, was out of range, or was not understood, or not the right number of parameters were sent.
ERR=04,MODULE NOT INSTALLED	Can not execute the command because the required instrument module is not installed.
ERR=20,CURRENT SOURCE NOT CONNECTED	For a resistance measurement command, the current source connection has not been made.
ERR=21,MEMORY FULL	For a file down transfer command, the medTester memory is full and can not accept anymore data to fulfill the transfer.
ERR=22,GFCI	A ground fault circuit interruption was triggered caused by a fault in the EUT plugged into the test receptacle. This error is not a response to a command. It appears whenever a ground fault occurs.
ERR=23,WRONG FILE	For a file transfer command where

ERROR RESPONSES	
Error Statement	Explanation
	the file has a name embedded into it, the wrong file was transferred.
ERR=24,LINE COUNT WRONG	For a file-up transfer command, the expected line count received did not agree with the count sent.
ERR=25,LINE COUNT WRONG	For a measurement command, the reading exceeds the range of the instrument.
ERR=26,TRANSFER ABORTED	After a file transfer download command, the file was aborted by the sending device.
ERR=27,TIMEOUT EXCEEDED	For a file transfer command, more than five (5) seconds has elapsed since the last character was received when more characters are needed to fulfill the transfer.

## File Transfer Protocol

### Note

The following information on file transfer protocol pertains to the transfer of checklist files into and test record files out of the medTester 5000C. The commands noted in this section are used as local commands by your Computerized Maintenance Management Software or PC, and require the use of medCheck. For more information about medCheck, see Chapter 11, *medCheck Module*.

Files sent from the medTester 5000C to a computer are said to be uploaded. Files sent from a computer to the medTester are said to be downloaded. Files consist of one or more lines of ASCII characters. For uploading, each line is terminated by a carriage return (CR) **and** a line feed (LF). For downloading, each line requires a carriage return (CR) **or** line feed (LF) to execute. The entire file is terminated by a form feed (FF), hex 0C.

### Expected Line Count

Since file loading is checked by keeping track of the number of lines in a file, the sending device tells the receiving device how many lines to expect (expected line count). Whenever files are transferred, the medTester displays a message that includes the current line count, continuously updated, as well as the expected line count.

### **Uploading**

Here is the file upload process:

- 1.** The medTester receives an uploading command from the computer in the form of a MUPUP, SDFUP, or AUTOSEQUP.
- 2.** medTester sends the expected line count to the computer.
- 3.** medTester receives the verified expected line count from the computer.
- 4.** If the line count numbers are the same, medTester sends the file. If the line count number is not the same, medTester sends the error message: ERR=24,LINE COUNT WRONG

### **Downloading**

The medTester 5000C receives file download commands from the remote computer in the form of a AUTOSEQDOWN or CHECKDOWN. CHECKDOWN involves the transmission of three files. Each file follows this sequence:

- 1.** medTester sends the acknowledgment response of a \* to the remote computer.
- 2.** The medTester receives the expected line count from the remote computer.
- 3.** If the expected line count is a valid integer in the correct range, the medTester next sends the expected line count back to the remote computer. If the line count integer is invalid, it sends the error message: ERR=03,ILLEGAL PARAMETER and quits.
- 4.** The medTester receives the file from the remote computer.
- 5.** In CHECKDOWN the first line contains the file name. If the medTester determines that the first line is incorrect, it sends the error message: ERR=23,WRONG FILE and quits.
- 6.** medTester checks the line count against the expected line count. If the count is correct, it sends the acknowledgment response of a \*. If the count is incorrect, it sends the error message: ERR=24,LINE COUNT WRONG and quits.
- 7.** If the file is sent correctly, the remote computer sends the medTester the acknowledgment response of \*. If the remote computer aborts the file transfer and knows the file was not sent correctly, it sends the medTester the ABORT message.

## Remote Commands List

Commands sent to the medTester from a remote computer include:

- General Administrative Commands,
- File Transfer Commands,
- Setup Commands,
- Measurement Commands, and
- Wave Commands.

GENERAL ADMINISTRATIVE COMMANDS	
Command	Explanation
REMOTE	Begins a remote mode session on the medTester 5000C.
REMOTE1	Begins a remote mode session on the medTester's COM1 port.
REMOTE2	Begins a remote mode session on the medTester's COM2 port.
LOC	Ends a remote session and returns the medTester 5000C to local mode.
IDENT	Asks the medTester for the instrument identification name, firmware version level, and any installed options separated by commas. Options can include: BARCODE; RS232/PRINTER; 100 RECORDS; EXPANDED MEMORY; WAVEFORM/EXTENDED TESTING; DATA TRANSFER; DEFIB, IPT; IV PUMP, IDA; ESU; SP02; EPA; NIBP; MEDCHECK.
SERN	Returns the medTester serial number in five (5) digits.
REV	Returns the firmware version number.
SETCLOCK=	<p>SETCLOCK sets the real time clock. Time is in a 24-hour format. Follow these conventions:</p> <p>Formatted as: Month, day, year, hour, minute, second. Separate each entry with a comma. Do not include spaces.</p> <p>For example, using the listed conventions, here is how you set <b>January 1, 1997, 2:11 P.M. and 14 seconds</b>—</p> <p style="text-align: center;"><i>1,1,97,14,11,14</i></p> <p>month: an integer 1 through 12            day: an integer 1 through 31            year: an integer 0 through 99            hour: an integer 0 through 23            minute: an integer 0 through 59            second: an integer 0 through 59.</p>

<b>FILE TRANSFER COMMANDS</b>	
(Note: Usage of these commands is described earlier.)	
Command	Explanation
AUTOSEQUP	Upload the file containing medTester autosequences.
AUTOSEQDOWN	Download the file containing medTester.
MUPUP	Upload all test records in the MUP file format.
SDFUP	Upload all test records in the SDF file format.
CHECKDOWN	Download checklists as three (3) files: IDN, ITM, and LST.

<b>SETUP COMMANDS</b>	
(Note: These commands set up measurement global variables for the test receptacle and the leakage test mode. At medTester power on, they reset to default which is <i>normal</i> for the test receptacle and <i>off</i> for the leakage DC test mode.)	
Command	Explanation
	MedTester responses to these commands is the * symbol.
TRGN	Sets the test receptacle ground to normal.
TRGO	Sets the test receptacle ground to open.
TRPN	Sets the test receptacle polarity to normal.
TRPR	Sets the test receptacle polarity to reverse.
TRNN	Sets the test receptacle neutral to normal.
TRNO	Sets the test receptacle neutral to open.
DCOFF	Sets the leakage DC test mode to off.
DCON	Sets the leakage DC test mode to on.

<b>MEASUREMENT COMMANDS</b>	
<p>Note: These commands set up a measurement, according to global variables as needed, and after a 0.5 second settling time, return the measurement reading. The measurement remains set up, so that additional readings can be taken with the REPEAT command. Global variables can be changed while the measurement remains set up, then more readings can again be taken with the REPEAT command. A measurement can be turned off by any non-measurement/non-setup command or by the EXIT command. While a measurement is set up, a new measurement command is allowed without previously exiting. The units of measurement are listed in parentheses. For ECG lead isolation tests, the isolation voltage stays on only during each measurement, then turns off. A REPEAT command would turn it back on as long as needed for the next measurement.</p>	
<b>Command</b>	<b>Explanation</b>
	The response is indicated with the unit of measurement listed in parentheses.
SV12	System voltage, hot to neutral. (V RMS)
SV1G	System voltage, neutral to ground. (V RMS)
SV2G	System voltage, hot to ground. (V RMS)
CLKE	Case leakage current, external leads. ( $\mu$ A RMS or DC)
CLKI	Case leakage current, internal leads. ( $\mu$ A RMS or DC)
XTMI	External meter leakage current. ( $\mu$ A)
ALGD	ECG leakage current, All leads to ground. ( $\mu$ A RMS or DC)
RLGD	ECG leakage current, Right Leg to ground. ( $\mu$ A RMS or DC)
RAGD	ECG leakage current, Right Arm to ground. ( $\mu$ A RMS or DC)
LAGD	ECG leakage current, Left Arm to ground. ( $\mu$ A RMS or DC)
LLGD	ECG leakage current, Left Leg to ground. ( $\mu$ A RMS or DC)
VGND	ECG leakage current, V leads to ground. ( $\mu$ A RMS or DC)
RLLD	ECG leakage current, Right Leg to leads. ( $\mu$ A RMS or DC)
RALD	ECG leakage current, Right Arm to leads.

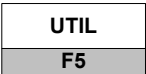


MEASUREMENT COMMANDS	
	( $\mu$ A RMS or DC)
LALD	ECG leakage current, Left Arm to leads. ( $\mu$ A RMS or DC)
LLLD	ECG leakage current, Left Leg to leads. ( $\mu$ A RMS or DC)
VLLD	ECG leakage current, V leads to leads. ( $\mu$ A RMS or DC)
EISO	ECG leakage current, All leads isolation. ( $\mu$ A RMS or DC)
RLIS	ECG leakage current, Right Leg isolation. ( $\mu$ A RMS or DC)
RAIS	ECG leakage current, Right Arm isolation. ( $\mu$ A RMS or DC)
LAIS	ECG leakage current, Left Arm isolation. ( $\mu$ A RMS or DC)
LLIS	ECG leakage current, Left Leg isolation. ( $\mu$ A RMS or DC)
VISO	ECG leakage current, V leads isolation. ( $\mu$ A RMS or DC)
ECUR	Equipment current. (A RMS)
CRST	Power cord resistance. (OHMS)
XTMR	Power cord resistance. (OHMS)
IPWR	Isolated power adapter leakage current. ( $\mu$ A RMS or DC)
TAC	Tachometer revolutions per minute. (RPM)
TEMP	Temperature. (DEG F or DEG C)
H2O	Humidity. (%)
REPEAT	Asks for another reading for the measurement which has already been set up by a previous command. Returns the reading.
EXIT	Turns off a measurement setup or wave which is running. Returns a *.
GTOL	Same as EXIT

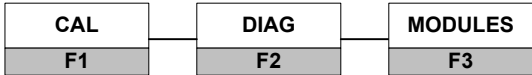
<b>WAVE COMMANDS</b>	
<p>Note: The following commands turn on the specified wave. The wave continues to run until it is changed by another wave command, or it will be turned off and disconnected by any non-wave command or the EXIT command.</p> <p>All wave commands return OK.</p>	
Command	Explanation
W000	Zero output.
W001	2 Hz square wave.
W002	4 second pulse.
W003	10 Hz sine wave.
W004	40 Hz sine wave.
W005	60 Hz sine wave.
W006	100 Hz sine wave.
W007	1 kHz square wave.
W008	2 Hz triangle wave.
W009	60 Hz common mode rejection test.
W010	Normal Sinus ECG at 30 BPM.
W011	Normal Sinus ECG at 60 BPM.
W012	Normal Sinus ECG at 120 BPM.
W013	Normal Sinus ECG at 240 BPM.
W014	0.5 Hz sine wave.
W015	Atrial fibrillation 1, course.
W016	2nd degree AV block, type 1, Wenckebach.
W017	2nd degree AV block, type 2.
W018	Missed beat at 80 BPM.
W019	Missed beat at 120 BPM.
W020	PVC type 1, left.
W021	PVC type 2, right.
W022	Multifocal PVCs.
W023	PVC 1, R on T.
W024	A pair or couplet of PVCs.
W025	Run of 5 PVCs.
W026	Run of 11 PVCs.
W027	Right bundle branch block.
W028	Ventricular tachycardia 180 BPM.
W029	Ventricular fibrillation.
W030	Asystole 2, flat.

## Port Diagnostics

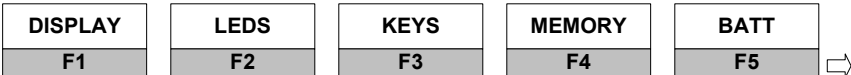
You can test the input and output of COM1 and COM2, as well as the output of the printer through the utilities menu on the medTester 5000C. From the main menu, MENU1, press:



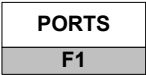
Next, from this menu press the right arrow to access the menu options:



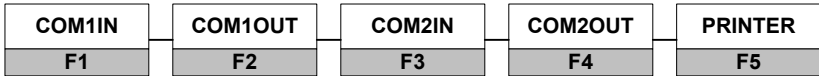
Select DIAG menu options to see:



Press the right arrow for:



Select the port and function you wish to test.



To test the input of COM1IN and COM2IN, ensure that the input device is attached and ready to transmit. After pressing the desired input, transmit data. The input data displays on the medTester in order to verify the working condition of the connection.



# Chapter 13

## The Wedge Adapter

*In this chapter you learn about the Wedge adapter and how to use it, how to attach it to the medTester 5000C, and how to configure ports to meet your needs.*

The medTester 5000C Wedge adapter is a medTester 5000C accessory that expands the number of available medTester 5000C serial communication ports from two to eight. When mounted under the medTester 5000C, the Wedge lets you connect multiple peripheral devices. Included on the Wedge is a PC-style external keyboard interface. The interface accepts either the PS/2- or AT-style keyboard. Wedge ports are easily user-configured for normal input and output, medTester autosequence operation, and medTester checklist commands.

### Features of the Wedge

As a medTester 5000C accessory, the Wedge offers users these features:

- Expansion of the medTester 5000C's COM2 serial port to eight ports.
- Keyboard interface to a standard PC-style keyboard.
- Laser bar code Scan Gun connection port.
- Simultaneous connection and control of multiple peripheral devices.
- Space-saving installation to the bottom of the medTester 5000C.
- Easy port configuration—including *on-the-fly* configuration changing.

## **Serial Port Expansion**

By expanding the number of available ports on a medTester 5000C with the Wedge, you have the flexibility to concurrently connect multiple, serial-controlled devices to the medTester 5000C. If you use the medTester 5000C's autosequences in conjunction with the Fluke Biomedical Impulse 4000 or IDA 4 Infusion Pump Tester, for example, the Wedge allows you to have both of these instruments connected to your medTester at the same time.

Any device you control from a medTester 5000C COM port can be connected to the Wedge. This could include the Fluke Biomedical medSim 300B Patient Simulator, the Model 214 B Patient Simulator, or the Model 217A Patient Simulator.

If you input data into your medTester 5000C directly from a serial keyboard or laser bar code scanning gun, you can attach these to the Wedge. If you use a Computerized Maintenance Management System or Equipment Management System on a personal computer, attach the computer to a Wedge port along with your other equipment. In addition, you can connect serial output devices, such as a test tag printer, to the Wedge.

## **Keyboard Interface**

With the Wedge you can connect any PC-style keyboard. Accepted keyboards include the Fluke Biomedical Mini AT-Style PC Keyboard accessory or any AT or PS/2 keyboard. The keyboard interface is on the side of the Wedge and includes both the AT and the PS/2 connector inputs.

## **Port Configuration**

Wedge serial ports are configured at the factory. However, you can easily configure them for your unique work situation. As described in the table below, you can configure Wedge ports in three ways—normal serial data input and output, medTester 5000C autosequences, and checklist commands.

When you execute a checklist, the medTester 5000C directs any *M*-type commands through the device connected to the checklist port. If the command requires a measurement response, for example, that input returns to the medTester through the checklist port as part of the test record. In addition, one or more ports can be used for autosequences. Defibrillator autosequences can execute through one port you define, IV pump autosequences through another port, and so on.

The table below describes the types of port configurations, their default port settings, and descriptions.

<b>Wedge Port Configurations</b>	
<b>Wedge Port Name (Default Wedge Port No.)</b>	<b>Description</b>
Normal (1)	<ul style="list-style-type: none"> <li>• Input in Local Mode—laser bar code scanning gun or a personal computer or terminal.</li> <li>• Output in Local Mode—for printing test records to a personal computer or compatible terminal device, or test tags to a serial printer.</li> <li>• Two-way Communications—medTester control from a remote personal computer or a compatible terminal device.</li> <li>• See Chapter 12, <i>Remote Operation</i> for more information.</li> </ul>
Defibrillator Autosequences (2)	<ul style="list-style-type: none"> <li>• Execute medTester 5000C autosequences A30-A49.</li> <li>• Specific to Impulse Models 4000 and 3000 Defibrillator Analyzers.</li> <li>• Both preprogrammed and user-configured autosequence types.</li> <li>• See Chapter 9, <i>Defibrillator Module</i>, for more information.</li> </ul>
External Pacemaker Tester (PACER) Autosequences (2)	<ul style="list-style-type: none"> <li>• Execute medTester 5000C PACER autosequences.</li> <li>• Compatible with the Impulse 4000 Analyzer Transcutaneous pacemaker testing features.</li> <li>• Both preprogrammed and user-configured autosequence types.</li> <li>• See Chapter 16, <i>Transcutaneous Pacemaker (Pacer) Module</i>, for more information.</li> </ul>
IV Pump Autosequences (3)	<ul style="list-style-type: none"> <li>• Execute medTester 5000C autosequences A50-A59.</li> <li>• Compatible with the IDA 4, Infutest 2000 series D, IPT-MC, and the IPT-I IV Pump Analyzers.</li> <li>• Both preprogrammed and user-configured autosequence types.</li> <li>• See Chapter 10, <i>IV Pump Module</i>, for more information.</li> </ul>
Electrosurgical Unit (ESU) Autosequences (4)	<ul style="list-style-type: none"> <li>• Execute medTester 5000C ESU autosequences.</li> <li>• Compatible with the Models 454A, RF303, and 402A ESU Analyzers.</li> <li>• Both preprogrammed and user-configured autosequence types.</li> <li>• See Chapter 14, <i>ESU Module</i>, for more information.</li> </ul>
Pulse Oximetry (SpO2) Autosequences (5)	<ul style="list-style-type: none"> <li>• Execute medTester 5000C SpO2 autosequences.</li> <li>• Compatible with the models Index 2XL, Oxitest PLUS, Oxitest PLUS7, and the CardioSat100 series SPO2 simulator.</li> <li>• Both preprogrammed and user-configured autosequence types.</li> <li>• See Chapter 15, <i>SPO2 Module</i>, for more information.</li> </ul>

Wedge Port Configurations	
Wedge Port Name (Default Wedge Port No.)	Description
Non-Invasive Blood Pressure (NIBP) Autosequences (7)	<ul style="list-style-type: none"> <li>Execute medTester 5000C NIBP autosequences.</li> <li>Specific to the CuffLink NIBP Analyzer.</li> <li>Both preprogrammed and user-configured autosequence types.</li> <li>See Chapter 17, <i>Non-Invasive Blood Pressure (NIBP) Module</i>.</li> </ul>
Checklist (8)	<ul style="list-style-type: none"> <li>Used when executing equipment-specific checklist, <b>M</b>-type checkitems <b>and</b> any medTester 5000C commands.</li> <li>Especially useful for devices that do not have their own autosequences, e.g., the medSim 300B Patient Simulator, the Model 214 B Patient Simulator, and the Model 217A Patient Simulator.</li> <li>Please see the following for more information:               <ul style="list-style-type: none"> <li>Chapter 11, <i>medCheck Module</i>.</li> <li>Chapter 12, <i>Remote Operation</i>.</li> <li>Operator's manual or user's guide section on serial port operation for the device under medTester 5000C control.</li> </ul> </li> </ul>

## Installing the Wedge

This section describes the procedure you use to install and connect the Wedge to the medTester 5000C. It includes instructions for disassembling the medTester 5000C's feet and tilt bail, and attaching the Wedge to the medTester 5000C and connecting required medTester 5000C-Wedge cables. See Figure 13-1, *Wedge Installation* at the end of this section.

Installing the Wedge to the bottom of a medTester 5000C is a quick and easy process. The only equipment needed to install the Wedge is a Phillips screwdriver, #2-type.

### **Warning!—UNPLUG THE INSTRUMENT POWER PLUG!**

Service should only be performed by qualified personnel. There are dangerous voltages present inside this instrument. Always unplug the power cord before opening the case. Never plug in the power cord while the case is open.



### **Disassembly of the medTester 5000C's Feet and Tilt Bail**

Disassemble the medTester 5000C feet and tilt bail. Prior to disassembly, clear the work area of any objects that could scratch or puncture the top of the medTester. Cover the work area with a cloth.

1. Turn the power off to the medTester.
2. Unplug the medTester from the power outlet.
3. Lay the medTester face down on the work area.
4. Using a #2-type Phillips screwdriver, unscrew and remove the screws holding the medTester feet and tilt bail. Save the screws, feet, and tilt bail for possible future use.

#### **Warning!**

The tilt bail is under tension.

### **Attaching the Wedge to the medTester 5000C**

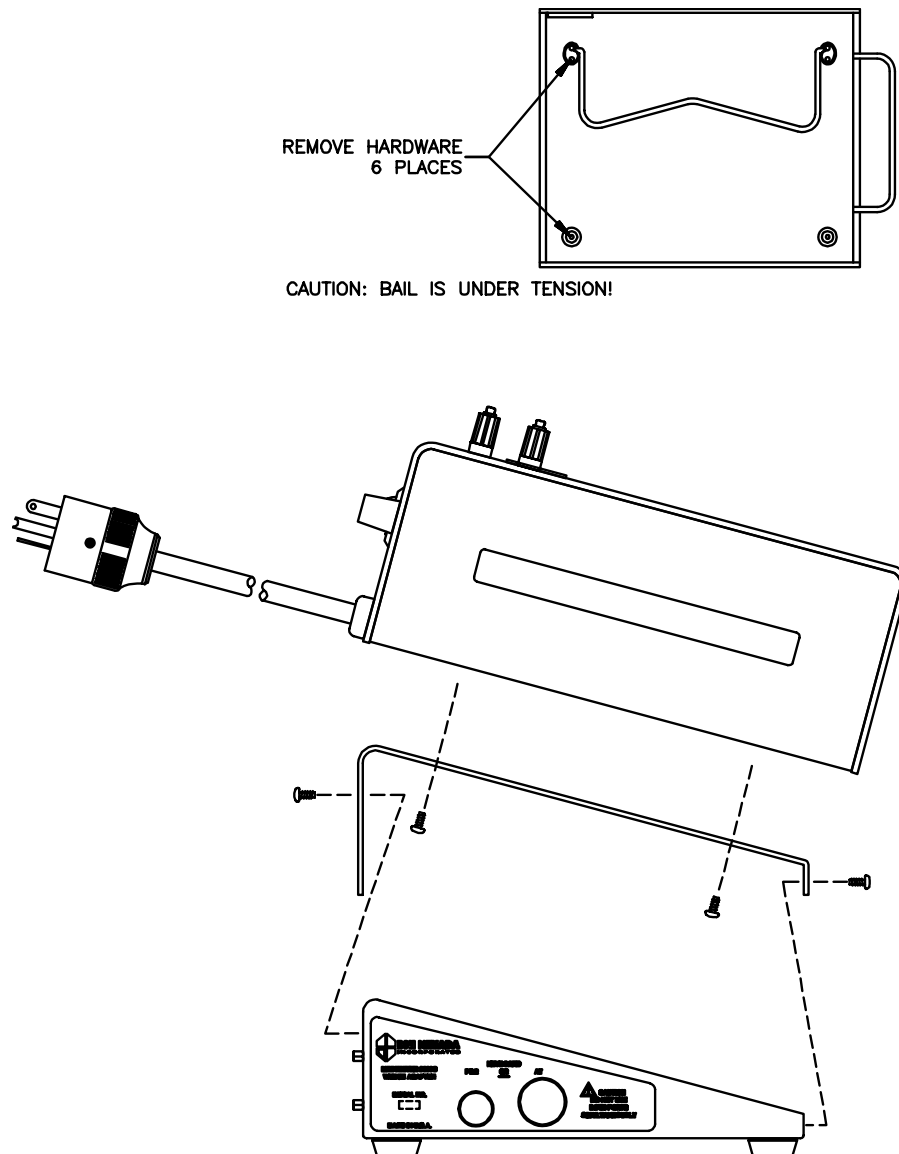
Attach the Wedge to the bottom of the medTester 5000C and connect the required cables:

1. Disassemble the two halves of the Wedge case.
2. Save the six screws, three from the front half, three from the rear half.
3. Lay the top cover of the Wedge on the bottom of the medTester, with the thick end of the Wedge toward the rear, and line up the screw holes on the Wedge to the screw holes on the medTester.
4. Using the four supplied screws, screw the Wedge top cover to the bottom of the medTester.
5. Place the bottom half of the Wedge, which contains the circuit board, into the Wedge cover.
6. Reassemble the Wedge by screwing together the two halves of the case using the original screws.
7. Connect the two Wedge cables from the Wedge to the medTester 5000C as follows:

FROM: Wedge Port (9-pin connection)	TO: medTester 5000C (25-pin connection)
MEDT COM1	COM1
MEDT COM2	COM2

**Note**

The COM1 cable is only needed if you want to use the Wedge keyboard interface. This cable routes the keyboard signal from the Wedge to the medTester. If you are not using the Wedge keyboard, the COM1 cable is not required. In that case, you can use COM1 as your regular serial port.



**Figure 13-1.** *Wedge Installation*

## Operating the Wedge

Operating the medTester 5000C with the Wedge consists of enabling the wedge, configuring your ports, setting baud rates, establishing output, and connecting your equipment. Knowing the equipment you want to connect to the Wedge helps determine how you may want to configure ports. Included at the end of this chapter are sample user situations. Reviewing these samples may give you some ideas as to how you can most efficiently use your Wedge.

The following sections describe how to operate the Wedge.

### Wedge Port Names

When you connect the Wedge to the medTester 5000C COM2 port, the additional ports are labeled COM2-1, COM2-2, COM2-3, etc. on the medTester 5000C display. These names correspond to the ports with their respective labels appearing on the Wedge. You also see these names in the medTester menus except when you configure ports for specific purposes.

### Enabling The Wedge

Enable the additional menu selections for the Wedge, COM2 serial ports. From Menu 1, press:



Select F2, ON, to enable, or F1, OFF, to disable the Wedge menu selections. Then press F5, STORE, to store.

### Configuring Wedge Ports

You can configure Wedge ports for three primary purposes—normal serial input and output, autosequences, and checklists:

### Configuring the Normal Port

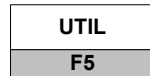
The Wedge normal port functions identically to the local input and output modes of the medTester 5000C's COM2 port. Therefore, configuring a normal port on the Wedge gives you another port for local mode input and output and for remote operation. As described in Chapter 12, *Remote Operation*, local mode input functions primarily include a laser barcode scanning gun or a personal computer. Local mode output functions primarily include output to a personal computer. You can also use the normal port for remote mode operation of the medTester.

#### Note

If you are using the Wedge keyboard interface, you have a Wedge cable connected to the medTester COM1 port. Therefore, use one of the Wedge COM2 ports as normal.

The normal port is configured as COM2-1 (Wedge port number one) by default. To configure a different port as the Wedge normal port:

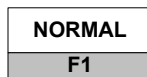
1. From the medTester 5000C main menu, MENU 1, press:



2. From the utility menu, press the medTester right arrow and enter the command:



3. Press:



SET WEDGE PORT FOR NORMAL I/O: 1



4. Press the medTester up arrow key to increment the number to the port you want as the normal port.
5. After selecting the normal port, press F5 to store your selection.

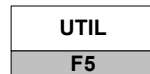
### Configuring an Autosequence Port

You can execute defibrillator, IV pump, ESU, and SPO2 autosequences through a Wedge port in the same manner that you can execute them through the medTester 5000C's COM2 port. This allows you, for example, to connect both a defibrillator analyzer such as the Impulse 3000 or the Impulse 4000 and an IV pump tester such as the IDA 4 to defined ports on the Wedge. Then whenever you execute one of these autosequences, the medTester 5000C knows to which port it must send the autosequence.

The medTester 5000C also uses the configured autosequence port for executing any autosequence that is embedded as a checkitem in a checklist. For example, if the medTester executes a checklist that contains a defibrillator autosequence, it directs that autosequence to the defibrillator autosequence port.

Each autosequence type has a default port setting. Defibrillator autosequences are assigned to the Wedge's COM2-2 port. Follow these instructions to configure a different port for defibrillator autosequences:

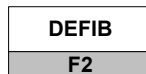
1. From the medTester 5000C main menu, MENU 1, press:



2. From the utility menu, press the medTester right arrow and enter the command:



3. Press:



to see this display:



4. Press the medTester up arrow key to increment the number to the port you want as the defibrillator autosequence port, or press the down arrow key to decrement the number.
5. After selecting the normal port, press F5 to store your selection.

Configure other autosequence ports as described here.

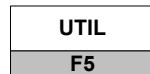
### Configuring the Checklist Port

Whenever you execute a checklist in the medTester 5000C that contains *M* commands that are external to the medTester, they are directed from the medTester to the Wedge checklist port. These external commands are executed only by the instrument to which they pertain.

Prior to executing a checklist containing external (*M*) commands, always ensure that you connect the instrument that can execute the command to the checklist port. For example, a *30Z* command can only be executed in the Fluke Biomedical 214B Patient Simulator, and the medTester 5000C will direct that command to the checklist port. Not connecting the 214B to this port will result in an error message appearing in the medTester 5000C display.

The default checklist port on the Wedge is COM2-8. Follow these instructions to configure a different checklist port:

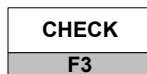
1. From the medTester 5000C main menu, MENU 1, press:



2. From the utility menu, press the medTester right arrow and enter the command:



3. Press the medTester right arrow to access additional menu options.



1. Press: to see this display:

SET WEDGE PORT FOR CHECKLISTS: 8



4. Press the medTester up arrow key to increment the number to the port you want as the defibrillator autosequence port, or press the down arrow key to decrement the number.

5. After selecting the normal port, press **F5** to store your selection.

### Changing the Checklist Port

In order to direct external (*M*) commands in checklists to a different Wedge port, you include a special checkitem command in the checklist that changes the checklist port for all subsequent external *M* commands. This is a type *M* command executed internally by the medTester. The command is:

**COM2PORT=*n***

where ***n*** is the new Wedge port, from 0 to 8. Setting the port to 0 turns it off.

### Configuring One Port for Two Purposes

You can also configure a single Wedge port to be an autosequence and checklist port. This lets you execute both a checklist *M* command and any autosequence contained within that checklist to a common instrument. One example of where this configuration could apply is with the Impulse 4000.

If you were testing the safety and performance of a defibrillator, you could use the medTester 5000C along with the Impulse 4000. In the medTester you would execute a checklist for this defibrillator. If the checklist contained the autosequence *A30*, the medTester would recognize that this is a defibrillator autosequence and would direct the autosequence to execute to the Wedge port to which the Impulse 4000 would be connected.

Later in the same checklist, a different checkitem could appear labeled *PLAYBACK* (an Impulse 4000 command). The medTester 5000C would recognize this as an external command and would direct the command to the Wedge's checklist port. The same Wedge port configured for defibrillator autosequences would also be configured as the checklist port. Therefore, this entire checklist would be run through the same port—to the Impulse 4000.

### Setting Baud Rates

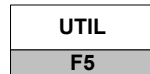
After you configure Wedge ports to meet your needs, you can set the baud rates for each port. Always set your Wedge port baud rate to match the baud rate setting of the instrument connected to that port. Check your instrument's user's guide for the baud rate setting before changing the setting for the Wedge port. This section shows you how to set Wedge port baud rates in the medTester 5000C.

**Note**

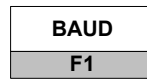
Autosequences always communicate at a fixed baud rate; therefore, you don't need to set the rate for any port used only for autosequences.

To set a Wedge port baud rate:

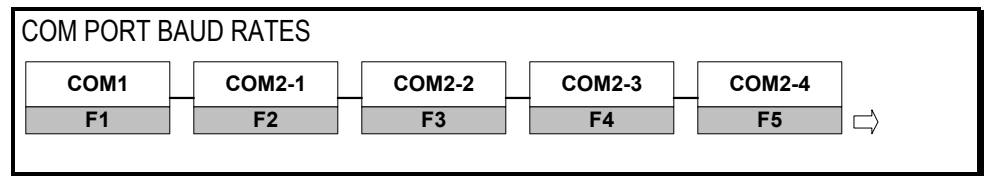
1. From the medTester 5000C main menu, MENU 1, press:



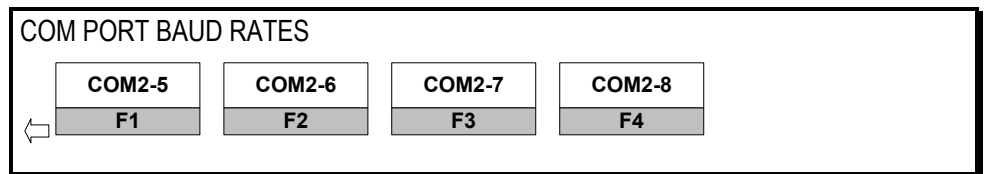
2. From the utility menu, press:



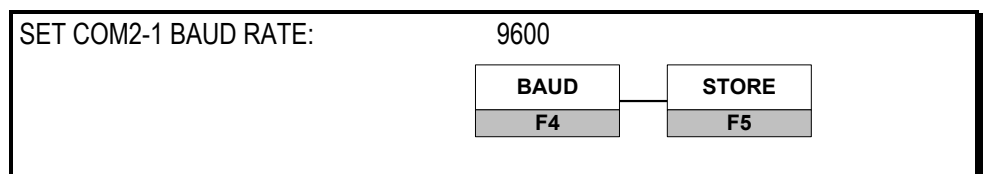
to see this display:



Pressing the medTester's right arrow lets you access the remaining port:



3. Press the function key that corresponds to the port you want, for example COM2-1.
4. Press F4 to change the baud rate value that appears in the display until you reach the value you want:



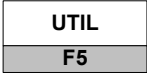


5. After setting the baud rate for the port, press F5 to store the setting.

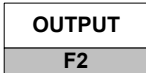
### Setting Output Ports

To configure a Wedge port for test record or test tag output, follow the directions below. This procedure sets the port output for test records and applies as well to setting a port for test tag output:

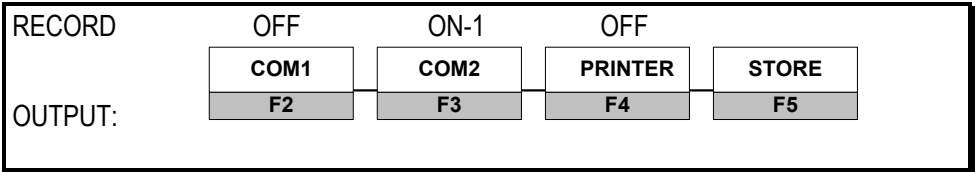
1. From the medTester 5000C main menu, MENU 1, press:



2. From the utility menu, press:



3. Pressing RECORDS, for example, displays these commands:



4. To output records to COM1, press F2. The display will change to show that COM1 is ON.
5. To output records to a Wedge port, press F3 to turn on that port. The display will change to show that, for example, COM2 is configured for record output on Wedge port four—ON-4.
6. When finished, press F5 to store the setting.



# Chapter 14

## ESU Module

*In this chapter you learn about using the medTester 5000C to control electro-surgery (ESU) autosequence tests with Fluke Biomedical ESU analyzers, what these tests are, and how to use them.*

### ESU Autosequences

ESU is an abbreviation for Electrosurgical Unit (or device). An ESU is a specialized instrument used as a high frequency and high voltage *electronic scalpel* to selectively cut or cauterize tissue during surgical procedures.

To install the ESU Module, you must first have installed the required prerequisite modules: RS-232/Printer, 100 Record Storage and Expanded Record Storage modules.

With the ESU module installed in your medTester 5000C, you have the capability of using a set of 10 autosequences to test and store test measurements on today's ESUs with a Fluke Biomedical ESU analyzer. Fluke's model 402A, 454A and RF303<sub>RS</sub> electrosurgical analyzers connect to the medTester's COM2 or designated Wedge port.

### Using the ESU Module with the Model 402A and RF303<sub>RS</sub> ESU Analyzer

The ESU module was originally designed to work with the Fluke Biomedical Model 454A ESU Analyzer. Fluke Biomedical's Model 402A and RF303<sub>RS</sub> ESU Analyzers are also compatible with the medTester, but operate differently sometimes from the Model 454A. The medTester can run ESU autosequences with these analyzers but must be customized for the capabilities of the ESU Analyzer connected. The Model 402A and RF303<sub>RS</sub> both have similar functionality. They have fewer test loads available, no plug-in modules, and connects for its test differently. They can not perform a return fault test. If an autosequence attempts to run a non-compatible test, it will not execute and the entire autosequence will be aborted. For further information on using the Model 402A with the medTester, please refer to Chapter 6, *Remote Operation: medTester 5000C Autosequence Operation*, in the Model 402A Operating Manual. Remember that you must use autosequences that are within the capability of the Model 402A.

When you connect a Fluke Biomedical ESU analyzer to your medTester and run ESU autosequences, the medTester displays prompts for your ESU setup and testing and test execution. The ESU analyzer returns measurement readings to the medTester, which displays them for you. If you have the medTester 5000C RS-232/Printer module and the Memory module, you can store and print test records.

Having the ESU module also offers you the ability to incorporate these autosequences into checklists if your medTester 5000C has the medCheck module installed.

For related information, see these chapters in this manual:

- Chapter 5, *Autosequences*.
- Chapter 6, *Customize Your medTester 5000C*—for customizing autosequences.
- Chapter 8, *Memory*—for test record storage and printing.

**Note**

Refer to your ESU analyzer operators manual for additional information regarding operation and range of available features.

To discover if you have the ESU module installed on your medTester 5000C, enter these menu commands:

<b>AUTO</b>	<b>ESU</b>
<b>F1</b>	<b>F4</b>

If ESU autosequences are installed, you see this message displayed:

**SELECT ESU AUTOSEQUENCE TO RUN**

The autosequence names appear below the message. To begin working with these autosequences, look at the table of ESU autosequence names.

If the ESU module has not been installed, this message appears on the display:

**MODULE NOT INSTALLED**

If the module was installed and you get this message, it may be necessary to re-enable the module. Refer to the “Enabling Modules” section of Chapter 2 – Installation.

## ESU Autosequence Names

You can begin any of the autosequences listed below from the medTester menu commands or directly by entering the keyboard shortcut command into the medTester. You can also include ESU autosequences as items in checklists. For more information about checklists, see Chapter 11, *medCheck Module*. See Chapter 12, *Remote Operation*, for information about remote mode of operation.

ESU AUTOSEQUENCES		
Autosequence Name	Keyboard Shortcut Command	Menu Commands from
		AUTO ESU
		F1 F4
ASPENX	A60	ASPENX F1
VLF30	A61	VLF30 F2
VLF40	A62	VLF40 F3
VLF4BF*	A63	VLF4BF F4
VLSSE4	A64	VLSSE4 F5
blank	A65	BLANK F1
blank	A66	BLANK F2
blank	A67	BLANK F3
blank	A68	BLANK F4
blank	A69	BLANK F5

\* Autosequence VLF4BF will abort if executed on the RF-303<sub>RS</sub> ESU Analyzer because it uses two Auxillary Return Fault tests the RF303<sub>RS</sub> can not execute.

## Running ESU Autosequence Tests

To begin running ESU autosequence tests, connect your medTester 5000C to your 454A ESU Analyzer. These two instruments are connected through the COM2 port on the medTester and the RS-232 serial port on the ESU analyzer. In addition, all ESU analyzers can alternately connect through the Wedge Port Expander.

**Note**

The medTester must be set to 2400 baud to communicate with the RF303RS. You can set the BAUD rate through the UTIL / RS232 PORT menu path.

**Note**

Refer to Chapter 1, *General Information - Accessories*, or the current Fluke Biomedical Price List for the correct serial cable part number needed.

From the medTester 5000C ESU menu, select the autosequence name for the autosequence you wish to run. The name and number of the selected autosequence appears on the display:

Press F5 for all device info prompts

If a safety autosequence has executed since power up of the medTester, you can have the medTester use the previously input prompt information for the current ESU autosequence, from this prompt:

USE PREVIOUS STARTING INFORMATION?

YES	NO
F1	F2

To accept previously input prompt information, press YES, and go to the *Test Sequence* section. If you choose NO, go to the *Pretest Device Prompts* section that follows.

### **Pretest Device Prompts**

There are eight prompts for information that can attach to test records. After selecting the desired autosequence, the medTester 5000C prompts you to enter device prompts. If you have some or all prompts turned off, the autosequence still gives you the brief opportunity to enter device information at the tests initiation with the message:

Press F5 for all device info prompts

- 1.** OP CODE—This is the operator code for the person doing the testing. This code can consist of a maximum of three characters which can be entered from the medTester keyboard. An example of an operator code could be a person's initials or employee number. The previous operator's code, if any, will appear. If the current operator has not changed from previous use, press the ENT key.
- 2.** TYPE—Enter the device name, code, or other descriptor for the equipment under test. This entry can be a maximum of 16 characters.
- 3.** MANF—Enter the name of the device manufacturer, 16 characters maximum.
- 4.** LOC—Type in the location of the device, 16 characters maximum. The previous location, if any, will appear. If this occurs and is the desired location, press the ENT key.
- 5.** MODEL—Enter the device model number, 16 characters maximum.
- 6.** SERIAL #—Type the device serial number, again 16 characters maximum.
- 7.** CONTROL #—Enter a control number with a maximum of 16 characters.



8. **PHYSICAL INSPECTION**—You have two physical inspection lines, each of which can consist of a maximum of 40 characters. After entering data for the first prompt, the second prompt appears.

**Note**

See Chapter 5, *Autosequences*, for a complete explanation of working with prompts. You can turn individual prompts on or off and rename prompts six through eight (6-8) from the list above. Chapter 6, *Customize Your medTester 5000C*, explains how to customize prompts.

**Test Sequence**

After you input pretest prompt information, ESU tests execute as described below:

1. Set the ESU analyzer serial port baud rate to 2400. The medTester uses the 2400 baud rate on COM2 for all communications with the ESU analyzer during an ESU autosequence.
2. At the beginning of an ESU autosequence, the medTester checks to make sure that an ESU analyzer is connected to COM2. If none is detected, the user can still go through the sequence in a simulation mode for demonstration purposes.
3. Each autosequence can contain up to 30 steps. Each step starts with a setup screen with the step number and type. Each step can be one of 4 types. Each type executes as described in the next section.

**ESU Test Types**

There are up to four types of tests that an ESU Analyzer can execute in analyzing an ESU. The number of test types available are dependent on the ESU Analyzer model and are described below.

**Generator Output**

This test measures the output of the ESU generator. It can use one of the ESU analyzer internal loads or an external load module (the RF303RS can not use external loads). The setup screen shows the load that will be used. If it is an external load module, then that module must be installed on the ESU analyzer.

The setup screen prompts the user to set up the ESU for power setting, mode, and output. Push **F5 READY** when the setup is complete. Connect the ESU device output leads to the ESU analyzer for a generator output measurement. Activate the ESU output to make a measurement.

The medTester measurement screen gets power readings continuously from the ESU analyzer and displays them. It continuously compares each reading with the plus and minus limits programmed for that step. Any readings outside of the limits are flagged and displayed with a "#" sign. When the ESU reading stabilizes, press **F5 HOLD** to freeze the reading.

The results screen shows the ESU power, Voltage peak to peak in kilovolts, crest factor (CF), and current. You can accept these readings for this step by pressing **F5 CONTINUE** or press **F4 REPEAT** if you want to go back to the measurement screen.

#### **Note**

When making generator output measurements with the 454A and an external load module, ignore the power and peak voltage readings on the 454A itself. They are not correct because the 454A assumes a different load in this mode. The displayed medTester readings are correct.

#### **RF Leakage**

RF leakage measures the leakage current of the ESU device. The setup screen shows the load to use, which can be an open load or one of the ESU analyzer internal loads (RF303<sub>RS</sub> open circuit only). The setup screen prompts the user to set up the ESU for power setting, mode, and output. Push **F5 READY** when the setup is complete.

Connect either the ESU active or dispersive electrode leads to the ESU analyzer for an RF leakage measurement according to the medTester prompt. Activate the ESU output to make a measurement.

The medTester measurement screen gets leakage current readings continuously from the ESU analyzer and displays them. When the ESU reading stabilizes, press **F5 HOLD** to freeze the reading. The results screen shows the leakage current. You can accept this reading for this step by pressing **F5 CONTINUE** or press **F4 REPEAT** if you want to go back to the measurement screen.

**CQM (Contact Quality Monitor) Test**

The CQM test measures the resistance needed by the ESU device to activate the CQM alarm. For this test the 454A requires an auxiliary module, either the REM/ARM module or the combined REM/ARM and Return Fault module (RARF).

Press **F5 READY** to start the test. Connect the ESU analyzer and the ESU device for a CQM (REM/ARM) test. On the 454A and 402, adjust the resistance on the module until the ESU alarm is activated. On the RF303<sub>RS</sub>, a CQM test uses the analyzer's main test load and defaults to 100 ohms. You can adjust this level when it is displayed on the RF303<sub>RS</sub> during a CQM test by pressing the INCREASE/DECREASE TEST LOAD keys on the RF303<sub>RS</sub> front panel until the desired resistance value is displayed. Press **F5 READ** to read the resistance on the medTester. You can accept this reading and store **PASS** or **FAIL** by pressing **F4 PASS** or **F5 FAIL** respectively. **FAIL** stores a "#" with the test record. You can press **F3 REPEAT** to go back to the measurement screen.

**Return Fault Test (for Model 454A only)**

This test checks the return fault monitor on an ESU. For this test the 454A requires the EM/ARM and Return Fault module (RARF). The setup screen prompts the user to set up the ESU for power setting and to select either the cut or coag side of the ESU device.

Press **F5 READY** to start. Connect the ESU to the ESU analyzer for a return fault monitor test. First, the ESU analyzer sets up the No Fault condition. The ESU should not alarm. Press **F4 PASS** or **F5 FAIL** to store the test results. As before, **FAIL** stores a "#" along with it. Second, the ESU analyzer sets up the Fault condition. The ESU should alarm. Press **F4 PASS** or **F5 FAIL** to store the test results.

The table beginning on the next page supplies specific information about the tests for each autosequence.

## ESU Autosequence Descriptions

Autosequence Number: A60						
Autosequence Name: ASPENX						
Step and Test Type	Load	ESU Mode	Output	Power Setting	Expected Power or Electrode	Limits
1 Generator Output	300 Ohms	Monopolar	Pure Cut	120	120 W	± 15%
2 Generator Output	300 Ohms	Monopolar	Pure Cut	300	300 W	± 15%
3 Generator Output	300 Ohms	Monopolar	Blend 1	69	69 W	± 15%
4 Generator Output	300 Ohms	Monopolar	Blend 1	180	180 W	± 15%
5 Generator Output	300 Ohms	Monocoag	Standard	48	48 W	± 15%
6 Generator Output	300 Ohms	Monocoag	Standard	120	120 W	± 15%
7 Generator Output	300 Ohms	Monocoag	Spray	40	40 W	± 15%
8 Generator Output	300 Ohms	Monocoag	Spray	80	80 W	± 15%
9 RF Leakage	Open	Monocoag	Standard	120	Active Electrode	N/A
10 RF Leakage	Open	Monocoag	Standard	120	Dispersive Electrode	N/A
11 RF Leakage	Open	Monopolar	Pure Cut	300	Active Electrode	N/A
12 RF Leakage	Open	Monopolar	Pure Cut	300	Dispersive Electrode	N/A
13 Generator Output	50 Ohms	Bipolar	Coag	20	20 W	± 20%
14 Generator Output	50 Ohms	Bipolar	Coag	50	50 W	± 15%
15 Generator Output	50 Ohms	Bipolar	Cut	20	20 W	± 20%
16 Generator Output	50 Ohms	Bipolar	Cut	50	50 W	± 15%

Autosequence Number: A61						
Autosequence Name: VLF30						
Step and Test Type	Load	ESU Mode	Output	Power Setting	Expected Power or Electrode	Limits
1 Generator Output	300 Ohms	Monocoag	Dessicate	200	200 W	± 15%
2 Generator Output	300 Ohms	Monocoag	Fulgurate	150	150 W	± 15%
3 Generator Output	300 Ohms	Monopolar	Pure Cut	300	300 W	± 15%
4 Generator Output	300 Ohms	Monopolar	Blend 1	250	250 W	± 15%
5 RF Leakage	Open	Monocoag	Dessicate	200	Active Electrode	N/A
6 RF Leakage	Open	Monocoag	Dessicate	200	Dispersive Electrode	N/A
7 RF Leakage	Open	Monopolar	Pure Cut	300	Active Electrode	N/A
8 RF Leakage	Open	Monopolar	Pure Cut	300	Dispersive Electrode	N/A
9 Generator Output	100 Ohms	Bipolar	Standard	50	50 W	± 15%
10 Generator Output	100 Ohms	Bipolar	Precise	50	50 W	± 15%

Autosequence Number: A62						
Autosequence Name: VLF40						
Step and Test Type	Load	ESU Mode	Output	Power Setting	Expected Power or Electrode	Limits
1 Generator Output	300 Ohms	Monocoag	Spray	150	150 W	± 15%
2 Generator Output	300 Ohms	Monopolar	Pure Cut	300	300 W	± 15%
3 Generator Output	300 Ohms	Monopolar	Blend 1	250	250 W	± 15%
4 Generator Output	300 Ohms	Monopolar	Blend 2	200	200 W	± 15%
5 Generator Output	300 Ohms	Monopolar	Dessicate	200	200 W	± 15%
6 Generator Output	300 Ohms	Monopolar	Fulgurate	150	150 W	± 15%
7 RF Leakage	Open	Monocoag	Dessicate	200	Active Electrode	N/A
8 RF Leakage	Open	Monocoag	Dessicate	200	Dispersive Electrode	N/A
9 RF Leakage	Open	Monopolar	Pure Cut	300	Active Electrode	N/A
10 RF Leakage	Open	Monopolar	Pure Cut	300	Dispersive Electrode	N/A
11 Generator Output	100 Ohms	Bipolar	Standard	50	50 W	± 15%
12 Generator Output	100 Ohms	Bipolar	Precise	50	50 W	± 15%

Autosequence Number: A63						
Autosequence Name: VLF4BF						
Step and Test Type	Load	ESU Mode	Output	Power Setting	Expected Power or Electrode	Limits
1 Generator Output	300 Ohms	Monocoag	Spray	50	50 W	± 20%
2 Generator Output	300 Ohms	Monocoag	Spray	120	120 W	± 20%
3 Generator Output	300 Ohms	Monocoag	Soft	60	60 W	± 20%
4 Generator Output	300 Ohms	Monocoag	Low V	99	99 W	± 20%
5 Generator Output	300 Ohms	Monopolar	Pure Cut	50	50 W	± 20%
6 Generator Output	300 Ohms	Monopolar	Pure Cut	300	300 W	± 20%
7 Generator Output	300 Ohms	Monopolar	Blend 1	250	250 W	± 20%
8 Generator Output	300 Ohms	Monopolar	Blend 2	50	50 W	± 20%
9 Generator Output	300 Ohms	Monopolar	Blend 2	200	200 W	± 20%
10 Generator Output	300 Ohms	Monopolar	Blend 3	200	200 W	± 20%
11 Generator Output	100 Ohms	Bipolar	Standard	70	70 W	± 20%
12 Generator Output	100 Ohms	Bipolar	Precise	70	70 W	± 20%
13 Auxiliary Return Fault Test	N/A	Cut Side	N/A	300	N/A	N/A
14 Auxiliary Return Fault Test	N/A	Coag Side	N/A	300	N/A	N/A
15 Auxiliary CQM Test	N/A	N/A	N/A	N/A	N/A	N/A

Autosequence Number: A64						
Autosequence Name: VLSSE4						
Step and Test Type	Load	ESU Mode	Output)	Power Setting	Expected Power or Electrode	Limits
1 Generator Output	300 Ohms	Monocoag	Spray	25	25 W	± 20%
2 Generator Output	300 Ohms	Monocoag	Spray	120	120 W	± 15%
3 Generator Output	300 Ohms	Monocoag	Soft	60	60 W	± 15%
4 Generator Output	300 Ohms	Monopolar	Pure Cut	75	75 W	± 15%
5 Generator Output	300 Ohms	Monopolar	Pure Cut	300	300 W	± 15%
6 Generator Output	300 Ohms	Monopolar	Blend 1	200	200 W	± 15%
7 Generator Output	300 Ohms	Monopolar	Blend 2	200	200 W	± 15%
8 Generator Output	300 Ohms	Monopolar	Blend 3	200	200 W	± 15%
9 Generator Output	300 Ohms	Monopolar	Blend 1	75	75 W	± 15%
10 Generator Output	300 Ohms	Monopolar	Blend 2	75	75 W	± 15%
11 Generator Output	300 Ohms	Monopolar	Blend 3	75	75 W	± 15%
12 Generator Output	100 Ohms	Bicoag	Standard	70	70 W	± 15%
13 Generator Output	100 Ohms	Bicoag	Precise	70	70 W	± 15%

### Posttest Prompts

When all tests are completed, the medTester 5000C prompts you for:

1. COMMENTS
2. NEXT TEST DUE DATE
3. USER TIME **EMS/CMMS system users:** User time is required
4. PRINT TEST TAG
5. STORE or PRINT TEST RECORD

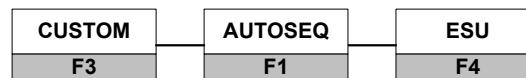


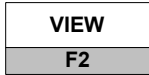
## Customizing ESU Autosequences

(For detailed information about customizing autosequences, please refer to Chapter 6, *Customize Your medTester 5000C*.)

To begin customizing ESU autosequences, you can view any of your current ones by entering these menu commands:

1. From the main menu, MENU1, press the right arrow to access MENU2.
2. Enter the menu commands:



3. From the ESU menu, select: 
4. Now select the autosequence you want to view.
5. Finally scroll through the steps in the sequence by using your up and down arrow keys.

### Make Your Own Autosequence

You can customize any of the 10 ESU autosequences, either the factory preprogrammed or the blank ones. This section describes the menu steps which you use to customize, or create, autosequences. Note that each customized autosequence can include as many as 30 steps. After you enter the step parameters you want, the medTester prompts you for more steps, if desired. If you do not want further steps in your autosequence, you can press END.

#### Note

You can find detailed information about customizing autosequences in Chapter 6, *Customize Your medTester 5000C*.

Begin by accessing the custom, autosequence, ESU menu as described above. This time, select:



Next, select the name of the autosequence you want to customize or create. Follow these steps, providing the desired information:

1. **Name**—This is the name you want to give to the autosequence, with a maximum of six characters.
2. Up to 30 measurement steps, of four possible types. For each step select F1 GENOUT for Generator Output, F2 RFLEAK for RF Leakage, F3 CQM for a CQM test, or F4 RETFLT for a Return Fault test. Then select the additional parameters needed for that type of test:

#### **Generator Output Test Type**

- **Load:** Select the test load, either an internal 50 to 1550 ohms in 50-ohm increments, or an external module of 25, 35, 50, 75, 125, 330, 2000, or 5000 ohms. Press F1 INT for an internal load or F2 EXT for an external load. And press F3 DEC or F4 INC to decrement or increment respectively through the available loads. Then press F5 OK to select it.

For the RF303RS, use on only internal loads between 50 and 750 ohms.

- **Mode:** Select the ESU mode to be used from MONOPOLAR, BIPOLAR, MONOCUT, MONOCOAG, BICUT, or BICOAG. Press F1 DEC or F2 INC to scroll through the available choices. Then press F5 OK to select it.
- **Output:** Select the ESU output type to be used from PURE CUT, CUT, BLEND 1-3, BLEND MAX, BLEND MIN, MICRO, COAG, STANDARD, PRECISE, LOW V, SOFT, SPRAY, DESICCATE, FULGURATE, TUBE CUT, HEMO 1-3, MACRO, PIN POINT, MODE 1-5, COAG 1-2, or USER 1-16 (see User Output Names, below). Press F1 DEC or F2 INC to scroll through the available choices. Then press F5 OK to select it.
- **Power Setting:** Enter the ESU power setting to be used, from 0 to 500.

- **Expected Power:** Enter the power expected to be generated by the ESU, from 0 to 500 W.
- **Power high limit** (00% = off)
- **Power low limit** (00% = off)

**RF Leakage Test Type**

- **Electrode:** Select either Active or Dispersive electrodes to test.
- **Load Status:** Select Open or Closed. For RF303<sub>RS</sub>, use only Open Load Status.
- **Load** (if Load Status Closed): Select an internal load (same as for Generator Output).
- **Mode:** Same as for Generator Output
- **Output:** Same as for Generator Output
- **Power Setting:** Same as for Generator Output

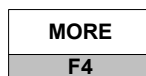
**Contact Quality Monitor (CQM) Test Type**

Nothing to select.

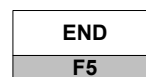
**Return Fault Test Type (not applicable to RF303<sub>RS</sub>)**

- **Test Side:** Select either Cut- or Coag-side ESU mode
- **Power Setting:** Same as for Generator Output

After each step selection, you can press



to select more steps, or



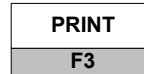
to end your selections.

After customizing your autosequence, the medTester prompts you to store the autosequence:



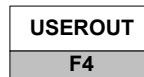
### Print Your Autosequence

Printing any autosequence is accomplished through this menu command:



### User Output Names

You can provide your own names for ESU Output. There are 16 names which can be programmed as desired. From the ESU custom autosequences menu described above, select:

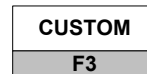


The display shows each User Output Name. Sequence to the next name with F4 NEXT. Rename the displayed name by pressing F3 RENAME, then entering the new name with a maximum of 10 characters. Go to the END with F5 END. Then store all the names if desired with F5 STORE.

### Reinitialize Factory Default Settings

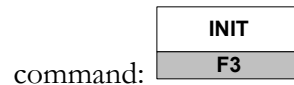
The autosequences can be returned to the factory default settings. To do this, enter these medTester commands:

1. From the medTester 5000C main menu, MENU 1, press the right arrow to access MENU 2.

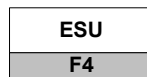


2. Enter the command:

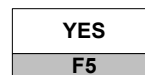
3. From the custom menu, press the right arrow and enter the



4. Choose:



5. To initialize ESU autosequences to defaults, press:



# Chapter 15

## SPO2 Module

*In this chapter you learn about using the medTester 5000C to control SPO2 autosequence tests with Fluke Biomedical SPO2 simulators, what these tests are, and how to use them.*

### SPO2 Autosequences

SPO2 is an abbreviation for the percentage of saturated pressure of oxygen (O<sub>2</sub>) gas in the blood—the percentage of oxygenated blood—as measured by a noninvasive pulse oximeter.

To install the SPO2 Module, you must first have installed the required prerequisite modules: RS-232/Printer, 100 Record Storage and Expanded Record Storage modules.

With the SPO2 module installed in your medTester 5000C, you have the capability of using a set of 10 autosequences to test and store test measurements on today's pulse oximeters with a Fluke Biomedical SPO2 simulator. The medTester is compatible with the Oxitest PLUS Pulse Oximeter Tester (Oxitest PLUS or Oxitest PLUS 7), the CardioSat 100 and the Index 2XL SPO2 Simulator. These SPO2 simulators connect to the medTester's COM1 or COM2 port or properly defined Wedge port.

#### **Note:**

An Index 2XL produced before 5/21/04 must be modified with ECO 4163 before it will operate through a wedge port.

#### **Note:**

The medTester can only be configured for one type of SPO2 Simulator at a time, either the Oxitest PLUS (including Oxitest

PLUS 7), the CardioSat 100 or Index 2XL. All autosequences stored by initialization, customization, or remote download will only work with the instrument for which they were designed.

When you connect the SPO2 simulator to your medTester and run SPO2 autosequences, the medTester controls the simulator, which simulates SPO2 conditions for the pulse oximeter to measure. The medTester provides a programmable settling time before oxygen saturation readings are documented. This settling time facilitates the SPO2 monitor using a beat-averaged measurement of oxygen saturation. You can enter a PASS or FAIL response or enter the data from the pulse oximeter into the test record. If you have the medTester 5000C RS-232/Printer module and the memory module, you can store and print test records.

Having the SPO2 module also offers you the ability to incorporate these autosequences into checklists if your medTester 5000C has the medCheck module installed.

For related information, see these chapters in this manual:

- Chapter 5, *Autosequences*.
- Chapter 6, *Customize Your medTester 5000C*—for customizing autosequences.
- Chapter 8, *Memory*—for test record storage and printing.

**Note**

Consult the operators manual for proper operation of your SPO2 simulator.

To discover if you have the SPO2 module installed on your medTester 5000C, enter these menu commands:

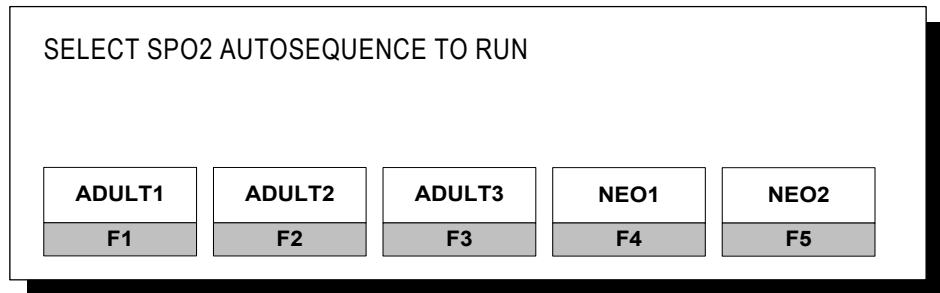


If the SPO2 module has not been installed, this message appears on the display:

**MODULE NOT INSTALLED**

If the module was installed and you get this message, it may be necessary to re-enable the module. Refer to the “Enabling Modules” section of Chapter 2 – Installation.

If SPO2 autosequences are installed, you see this message displayed:



The above display format and testing protocol is formatted for the Oxitest PLUS pulse Oximeter Tester.

If you wish to use the CardioSat 100 pulse Oximeter Tester or Index 2XL SPO Simulator, go to the following section of this chapter “*Customizing SPO2 Test-Configuring for your pulse Oximeter Tester*”.

### **SPO2 Autosequence Names**

You can begin any of the autosequences listed below from the medTester menu commands or directly by entering the keyboard shortcut command into the medTester. You can also include SPO2 autosequences as items in checklists. For more information about checklists, see Chapter 11, *medCheck Module*. See Chapter 12, *Remote Operation*, for information about remote mode of operation.

<b>SP02 AUTOSEQUENCES FOR OXITEST PLUS</b>				
<b>Autosequence Name</b>	<b>Keyboard Shortcut Command</b>	<b>Menu Commands from</b>		
		<table border="1"> <tr> <td><b>AUTO</b></td> <td><b>SPO2</b></td> </tr> <tr> <td><b>F1</b></td> <td><b>F5</b></td> </tr> </table>	<b>AUTO</b>	<b>SPO2</b>
<b>AUTO</b>	<b>SPO2</b>			
<b>F1</b>	<b>F5</b>			
		<b>Menu Command MENU 1</b>		
ADULT1	A70	<table border="1"> <tr> <td><b>ADULT 1</b></td> </tr> <tr> <td><b>F1</b></td> </tr> </table>	<b>ADULT 1</b>	<b>F1</b>
<b>ADULT 1</b>				
<b>F1</b>				
ADULT2	A71	<table border="1"> <tr> <td><b>ADULT 2</b></td> </tr> <tr> <td><b>F2</b></td> </tr> </table>	<b>ADULT 2</b>	<b>F2</b>
<b>ADULT 2</b>				
<b>F2</b>				
ADULT3	A72	<table border="1"> <tr> <td><b>ADULT 3</b></td> </tr> <tr> <td><b>F3</b></td> </tr> </table>	<b>ADULT 3</b>	<b>F3</b>
<b>ADULT 3</b>				
<b>F3</b>				
NEO1	A73	<table border="1"> <tr> <td><b>NEO 1</b></td> </tr> <tr> <td><b>F4</b></td> </tr> </table>	<b>NEO 1</b>	<b>F4</b>
<b>NEO 1</b>				
<b>F4</b>				
NEO2	A74	<table border="1"> <tr> <td><b>NEO 2</b></td> </tr> <tr> <td><b>F5</b></td> </tr> </table>	<b>NEO 2</b>	<b>F5</b>
<b>NEO 2</b>				
<b>F5</b>				
		<b>Menu Command MENU 2</b>		
blank	A75	<table border="1"> <tr> <td><b>BLANK</b></td> </tr> <tr> <td><b>F1</b></td> </tr> </table>	<b>BLANK</b>	<b>F1</b>
<b>BLANK</b>				
<b>F1</b>				
blank	A76	<table border="1"> <tr> <td><b>BLANK</b></td> </tr> <tr> <td><b>F2</b></td> </tr> </table>	<b>BLANK</b>	<b>F2</b>
<b>BLANK</b>				
<b>F2</b>				
blank	A77	<table border="1"> <tr> <td><b>BLANK</b></td> </tr> <tr> <td><b>F3</b></td> </tr> </table>	<b>BLANK</b>	<b>F3</b>
<b>BLANK</b>				
<b>F3</b>				
blank	A78	<table border="1"> <tr> <td><b>BLANK</b></td> </tr> <tr> <td><b>F4</b></td> </tr> </table>	<b>BLANK</b>	<b>F4</b>
<b>BLANK</b>				
<b>F4</b>				
blank	A79	<table border="1"> <tr> <td><b>BLANK</b></td> </tr> <tr> <td><b>F5</b></td> </tr> </table>	<b>BLANK</b>	<b>F5</b>
<b>BLANK</b>				
<b>F5</b>				



SP02 AUTOSEQUENCES FOR INDEX 2XL				
Autosequence Name	Keyboard Shortcut Command	Menu Commands from		
		<table border="1"> <tr> <td>AUTO</td> <td>SPO2</td> </tr> <tr> <td>F1</td> <td>F5</td> </tr> </table>	AUTO	SPO2
AUTO	SPO2			
F1	F5			
		Menu Command MENU 1		
NELLCR	A70	<table border="1"> <tr> <td>NELLCR</td> </tr> <tr> <td>F1</td> </tr> </table>	NELLCR	F1
NELLCR				
F1				
OHMNOV	A71	<table border="1"> <tr> <td>OHMEDA</td> </tr> <tr> <td>F2</td> </tr> </table>	OHMEDA	F2
OHMEDA				
F2				
PMS	A72	<table border="1"> <tr> <td>HPMERLN</td> </tr> <tr> <td>F3</td> </tr> </table>	HPMERLN	F3
HPMERLN				
F3				
DATEX	A73	<table border="1"> <tr> <td>DATEX</td> </tr> <tr> <td>F4</td> </tr> </table>	DATEX	F4
DATEX				
F4				
GENERC	A74	<table border="1"> <tr> <td>GENERC</td> </tr> <tr> <td>F5</td> </tr> </table>	GENERC	F5
GENERC				
F5				
		Menu Command MENU 2		
blank	A75	<table border="1"> <tr> <td>BLANK</td> </tr> <tr> <td>F1</td> </tr> </table>	BLANK	F1
BLANK				
F1				
blank	A76	<table border="1"> <tr> <td>BLANK</td> </tr> <tr> <td>F2</td> </tr> </table>	BLANK	F2
BLANK				
F2				
blank	A77	<table border="1"> <tr> <td>BLANK</td> </tr> <tr> <td>F3</td> </tr> </table>	BLANK	F3
BLANK				
F3				
blank	A78	<table border="1"> <tr> <td>BLANK</td> </tr> <tr> <td>F4</td> </tr> </table>	BLANK	F4
BLANK				
F4				
blank	A79	<table border="1"> <tr> <td>BLANK</td> </tr> <tr> <td>F5</td> </tr> </table>	BLANK	F5
BLANK				
F5				

SPO2 AUTOSEQUENCES FOR CARDIOSAT 100		
Autosequence Name	Keyboard Shortcut Command	Menu Commands from
		AUTO F1      SPO2 F5
		<b>Menu Command MENU 1</b>
NELLCR	A70	NELLCR F1
OHMEDA	A71	OHMEDA F2
HPMERLN	A72	HPMERLN F3
DATEX	A73	DATEX F4
GENERC	A74	GENERC F5
		<b>Menu Command MENU 2</b>
blank	A75	BLANK F1
blank	A76	BLANK F2
blank	A77	BLANK F3
blank	A78	BLANK F4
blank	A79	BLANK F5

## Running SPO2 Autosequence Tests

To begin running SPO2 autosequence tests, connect your medTester 5000C to your SPO2 simulator. These three instruments can be connected through the COM1 or COM2 ports or Wedge Port expander on the medTester and the RS-232 serial port on the SPO2 simulator.

**Note**

The Index 2XL must have been manufactured after 5/21/04 or modified by Fluke Biomedical (ECO 4163) to communicate through the Wedge Port Expander.

**Note**

Refer to Chapter 1, *General Information – Accessories*, or the current Fluke Biomedical Price List for the correct serial cable part number needed.

From the medTester 5000C SPO2 menu, select the autosequence name for the autosequence you wish to run. The name and number of the selected autosequence appears on the display:

Press F5 for all device info prompts

If a safety autosequence has executed since power up of the medTester, you can have the medTester use the previously input prompt information for the current SPO2 autosequence, from this prompt:

USE PREVIOUS STARTING INFORMATION?	
YES	NO
F1	F2

To accept previously input prompt information, press YES, and go to *Test Sequence* below. If you choose NO, go to the prompt instructions below.

## **Pretest Device Prompts**

There are eight prompts for information that you can attach to test records. After selecting the desired autosequence, the medTester 5000C prompts you to enter device prompts. If you have some or all prompts turned off, the autosequence still gives you the brief opportunity to enter device information at the test's initiation with the message:

Press F5 for all device info prompts

- 1.** OP CODE—This is the operator code for the person doing the testing. This code can consist of a maximum of three characters that can be entered from the medTester keyboard. An example of an operator code could be a person's initials or employee number. The previous operator's code, if any, will appear. If the current operator has not changed from previous use, press the ENT key.
- 2.** TYPE—Enter the device name, code, or other descriptor for the equipment under test. This entry can be a maximum of 16 characters.
- 3.** MANF—Enter the name of the device manufacturer, 16 characters maximum.
- 4.** LOC—Type in the location of the device, 16 characters maximum. The previous location, if any, will appear. If this occurs and is the desired location, press the ENT key.
- 5.** MODEL—Enter the device model number, 16 characters maximum.
- 6.** SERIAL #—Type the device serial number, again 16 characters maximum.
- 7.** CONTROL #—Enter a control number with a maximum of 16 characters.
- 8.** PHYSICAL INSPECTION—You have two physical inspection lines, each of which can consist of a maximum of 40 characters. After entering data for the first prompt, the second prompt appears.

**Note**

See Chapter 5, *Autosequences*, for a complete explanation of working with prompts. You can turn individual prompts on or off and rename prompts six through eight (6-8) from the list above. Chapter 6, *Customize Your medTester 5000C*, explains how to customize prompts.

**Test Sequence**

After you input pretest prompt information, SPO2 tests execute as described here.

Connect the SPO2 monitor optical probe or electrical simulation cable to the SPO2 simulator.

The Oxitest PLUS runs at a fixed 9600 baud rate. For a CardioSat 100 or INDEX 2XL, set the baud rate to 2400. The medTester uses these baud rates on COM1 or COM2 ports or Wedge Port expander for all communications with an SPO2 simulator during an SPO2 autosequence.

The Oxitest PLUS is ready to go any time it is powered up.

The CardioSat 100 and Index 2XL must be freshly powered up and at Main Menu 1 to accept commands from the medTester. If the CardioSat 100 has been on, turn it off. Then turn it on again.

At the beginning of an SPO2 autosequence, the medTester checks to make sure that an SPO2 simulator is connected to COM1 or COM2 ports or Wedge Port expander. If none is detected, the medTester displays “NO INDEX 2XL DETECTED...”. At this point you can still go through the sequence in a simulation mode for demonstration purposes.

For the Oxitest PLUS, you are prompted to set the SPO2 simulator to a specific oximeter and sensor.

For the CardioSat 100 and INDEX 2XL, if a manufacturer has been specified as part of the autosequence, the medTester will command the SPO2 simulator to set up for it. If the manufacturer has been *Not Specified*, the user will be prompted by the medTester to set the SPO2 simulator to a specific "make" before proceeding.

Each autosequence can contain up to ten SPO2 simulation steps, except the INDEX 2XL which can contain up to 15 SPO2 steps. After those, several special tests will be performed if they have been programmed into the autosequence.

### **SPO2 Simulation Steps**

For each step the medTester commands the SPO2 simulator to set up a simulation of the programmed SPO2 in percentage, heart rate in beats per minute (BPM), and amplitude in percentage. For a given step, only the commands necessary for a change are sent.

For the Oxitest Plus, the medTester also sets up the programmed artifact.

For the CardioSat 100 and Index 2XL, the commands sent to the SPO2 simulator are noted on the medTester display to show you what is happening.

For the Index 2XL, the medTester can also be set up for Motion-Preset Tests based on either Level 1 or Level 2 tests. The tables below show the eight motion presets for each of the two levels of tests.

<b>LEVEL 1</b>			
<b>PRESET</b>	<b>NAME</b>	<b>SPO2 %</b>	<b>RATE BPM</b>
08	Normal/Tap	98	55
09	Normal/Shiver	98	55
10	Weak/Tap	90	95
11	Weak/Shiver	90	94
12	Brad/Tap	88	45
13	Hyoxic/Tap	70	95
14	Hyoxic/Shiver	70	95
15	Neonate/Shiver	90	180

<b>LEVEL 2</b>			
<b>PRESET</b>	<b>NAME</b>	<b>SPO2 %</b>	<b>RATE BPM</b>
16	BradyTap#2	88	45
17	Hyox/Tap#2	70	95
18	WeakTap#2	80	95
19	NormalTap#2	93	55
20	Asystole	91	90
21	LowFreq1	80	75
22	LowFreq2	70	75
23	SlowTap	80	75

For the CardioSat 100 and the INDEX 2XL, the commands sent to the SPO2 simulator are noted on the medTester display to show you what is happening.

The medTester waits for the programmed number of heartbeats for a settling time for the pulse oximeter. The medTester beeps when settling is finished.

You should now observe the readings on the pulse oximeter for SPO2 and heart rate. You can enter test results in two ways:

1. You can make a judgment yourself and press F1 PASS or F2 FAIL to store with the record. FAIL is stored with a "#".
2. Or you can press F3 DATA to enter the actually observed pulse oximeter readings into the medTester using the numeric, UP/DOWN, and LEFT/RIGHT keys, followed by ENT to complete. Now the medTester will compare entered data to the preset limits for SPO2 and heart rate. If any readings are out of limits, the medTester will note that and give you a chance to repeat the test.

### **SPO2 Alarm Test**

This test measures how long it takes for the pulse oximeter to alarm after the SPO2 goes to either a high or a low level.

First the medTester sets the SPO2 simulator to the programmed alarm starting values for SPO2, heart rate, and amplitude. After settling, you can press F5 START to go to the programmed high SPO2 alarm value. The medTester then sets the SPO2 simulator to the high alarm value and waits for you to press F1 when the pulse oximeter alarms, thus recording the time taken to alarm. The results are displayed and the option is offered to repeat the test if desired.

Next the low SPO2 alarm is tested in the same way.

### **Rate Alarm Test**

Similarly, the rate alarm test is performed for high and low rates.

### **Asystole Test**

Similarly, the asystole alarm is tested. For this test the amplitude is set to zero percent to go to asystole.

### **Amplitude Test**

This test measures what amplitude is the minimum that can be detected by the pulse oximeter.

First, the medTester sets up the starting alarm test values, except amplitude is set to start at ten percent. You are prompted to find the threshold that is the lowest amplitude that will still be recognized by the pulse oximeter.

You can use the UP/DOWN keys to change the amplitude display on the medTester, then you must press F5 APPLY to command the SPO2 simulator to move to the new amplitude. When you find the threshold, press F5 STORE to record the results.

## **Probe Test**

For the Oxitest PLUS, there is no probe test built-in. However, it is still possible to include a probe test in an autosequence. In this case, simply test the probe some other way and record the test result during the autosequence by pressing PASS or FAIL.

The CardioSat 100 version E and EF have a built-in probe test feature

### **Note:**

For the Cardiosat 100, if you used the electrical simulation technique to perform the earlier tests, either disconnect the electrical simulation adapter from the CardioSat 100 or turn the SPO2 monitor power off before performing the probe test. This electrical signal can interfere with the proper operation of the probe test.

The autosequence performs the regular CardioSat 100 probe test and records the results. Prepare for the test by connecting the probe to be tested to the appropriate connector on the CardioSat 100 with the applicable adapter cable. Then press F5 START and wait for the results.

When the test is done, you can read the results with the DOWN/UP keys, then press F5 END. You can repeat the test if desired.

The table beginning on the next page supplies specific information about the tests for each factory initialized autosequence.



**For the Oxitest PLUS:**

SPO2 Autosequence Number: A70					
Autosequence Name: ADULT1					
Settling Time: 25 Beats					
Heart Rate Limit: $\pm 4$ BPM (beats per minute)					
Step Number	SPO2 ( in percent)	SPO2 Limit (in percent)	Heart Rate (in BPM)	Amplitude (in percent)	Artifact
1	97	$\pm 4$	75	100	Off
2	97	$\pm 4$	45	100	Off
3	97	$\pm 4$	180	100	Off
4	80	$\pm 4$	45	100	Off
5	90	$\pm 4$	120	100	Off
6	80	$\pm 4$	180	100	Off

SPO2 Autosequence Number: A71					
Autosequence Name: ADULT2					
Settling Time: 25 Beats					
Heart Rate Limit: $\pm 4$ BPM (beats per minute)					
Step Number	SPO2 ( in percent)	SPO2 Limit (in percent)	Heart Rate (in BPM)	Amplitude (in percent)	Artifact
1	97	$\pm 4$	75	100	Off
2	97	$\pm 4$	45	100	Off
3	97	$\pm 4$	180	100	Off
4	80	$\pm 4$	45	100	Off
5	90	$\pm 4$	120	100	Off
6	80	$\pm 4$	180	100	Off
Starting Alarm Value for SPO2: 93% Starting Alarm Value for Rate: 75 BPM Starting Alarm Value for Amplitude: 100% SPO2 Alarm Test: Hi-97% Lo-80% Rate Alarm Test: Hi-140 BPM Lo-50 BPM Asystole Test Amplitude Test Probe Test					

## For the Oxitest PLUS:

SPO2 Autosequence Number: A72					
Autosequence Name: ADULT3					
Settling Time: 25 Beats					
Heart Rate Limit: $\pm 4$ BPM (beats per minute)					
Step Number	SPO2 (in percent)	SPO2 Limit (in percent)	Heart Rate (in BPM)	Amplitude (in percent)	Artifact
1	97	$\pm 4$	75	100	Off
2	97	$\pm 4$	45	100	Off
3	97	$\pm 4$	180	100	Off
4	80	$\pm 4$	45	100	Off
5	90	$\pm 4$	120	100	Off
6	80	$\pm 4$	180	100	Off
7	97	$\pm 4$	66	4	Off
8	97	$\pm 4$	70	33	Movement
9	97	$\pm 4$	80	52	Tremor
Starting Alarm Value for SPO2: 93% Starting Alarm Value for Rate: 75 BPM Starting Alarm Value for Amplitude: 100% SPO2 Alarm Test: Hi-97% Lo-80% Rate Alarm Test: Hi-140 BPM Lo-50 BPM Asystole Test Amplitude Test Probe Test					

SPO2 Autosequence Number: A73					
Autosequence Name: NEO1					
Settling Time: 25 Beats					
Heart Rate Limit: $\pm 6$ BPM (beats per minute)					
Step Number	SPO2 (in percent)	SPO2 Limit (in percent)	Heart Rate (in BPM)	Amplitude (in percent)	Artifact
1	93	$\pm 4$	145	40	Off
2	93	$\pm 4$	75	40	Off
3	93	$\pm 4$	225	40	Off
4	97	$\pm 4$	225	40	Off
5	80	$\pm 4$	60	40	Off
6	93	$\pm 4$	145	40	Movement
7	93	$\pm 4$	145	40	Tremor

**For the Oxitest PLUS:**

SPO2 Autosequence Number: A74					
Autosequence Name: NEO2					
Settling Time: 25 Beats					
Heart Rate Limit: $\pm 6$ BPM (beats per minute)					
Step Number	SPO2 (in percent)	SPO2 Limit (in percent)	Heart Rate (in BPM)	Amplitude (in percent)	Artifact
1	93	$\pm 4$	145	40	Off
2	93	$\pm 4$	75	40	Off
3	93	$\pm 4$	225	40	Off
4	97	$\pm 4$	225	40	Off
5	80	$\pm 4$	60	40	Off
6	93	$\pm 4$	145	40	Movement
7	93	$\pm 4$	145	40	Tremor
Starting Alarm Value for SPO2: 93% Starting Alarm Value for Rate: 145 BPM Starting Alarm Value for Amplitude: 40% SPO2 Alarm Test: Hi-97% Lo-90% Rate Alarm Test: Hi-165 BPM Lo-95 BPM Asystole Test Amplitude Test Probe Test					

## For CardioSat 100:

SPO2 Autosequence Number: A70				
Autosequence Name: NELLCR				
Manufacturer: Nellcor				
Settling Time: 25 Beats				
Heart Rate Limit: $\pm 4$ BPM (beats per minute)				
Step Number	SPO2 (in percent)	SPO2 Limit (in percent)	Heart Rate (in BPM)	Amplitude (in percent)
1	96	$\pm 3$	75	100
2	98	$\pm 3$	230	100
3	81	$\pm 4$	38	25
4	81	$\pm 4$	112	100
5	81	$\pm 4$	201	100
6	92	$\pm 3$	75	100
7	82	$\pm 4$	75	100
8	72	$\pm 5$	75	100
9	98	$\pm 3$	30	100

Starting Alarm Value for SPO2: 96%  
Starting Alarm Value for Rate: 75 BPM  
Starting Alarm Value for Amplitude: 100%  
SPO2 Alarm Test: Hi-100% Lo-85%  
Rate Alarm Test: Hi-140 BPM Lo-50 BPM  
Asystole Test  
Amplitude Test  
Probe Test

SPO2 Autosequence Number: A71				
Autosequence Name: OHMEDA				
Manufacturer: Ohmeda 3700				
Settling Time: 25 Beats				
Heart Rate Limit: $\pm 4$ BPM (beats per minute)				
Step Number	SPO2 (in percent)	SPO2 Limit (in percent)	Heart Rate (in BPM)	Amplitude (in percent)
1	96	$\pm 3$	75	100
2	98	$\pm 3$	230	100
3	92	$\pm 3$	75	100
4	82	$\pm 4$	75	100
5	72	$\pm 5$	75	100
6	98	$\pm 3$	45	100

Starting Alarm Value for SPO2: 96%  
Starting Alarm Value for Rate: 75 BPM  
Starting Alarm Value for Amplitude: 100%  
SPO2 Alarm Test: Hi-100% Lo-85%  
Rate Alarm Test: Hi-140 BPM Lo-50 BPM  
Asystole Test  
Amplitude Test  
Probe Test

## For CardioSat 100:

SPO2 Autosequence Number: A72				
Autosequence Name: HPMRLN				
Manufacturer: Hewlett Packard Merlin Series				
Settling Time: 25 Beats				
Heart Rate Limit: $\pm 4$ BPM (beats per minute)				
Step Number	SPO2 (in percent)	SPO2 Limit (in percent)	Heart Rate (in BPM)	Amplitude (in percent)
1	96	$\pm 3$	75	100
2	98	$\pm 3$	230	100
3	92	$\pm 3$	75	100
4	82	$\pm 4$	75	100
5	72	$\pm 5$	75	100
6	98	$\pm 3$	45	100
Starting Alarm Value for SPO2: 96% Starting Alarm Value for Rate: 75 BPM Starting Alarm Value for Amplitude: 100% SPO2 Alarm Test: Hi-100% Lo-85% Rate Alarm Test: Hi-140 BPM Lo-50 BPM Asystole Test Amplitude Test Probe Test				

SPO2 Autosequence Number: A73				
Autosequence Name: DATEX				
Manufacturer: Datex				
Settling Time: 25 Beats				
Heart Rate Limit: $\pm 4$ BPM (beats per minute)				
Step Number	SPO2 (in percent)	SPO2 Limit (in percent)	Heart Rate (in BPM)	Amplitude (in percent)
1	96	$\pm 3$	75	100
2	98	$\pm 3$	230	100
3	92	$\pm 3$	75	100
4	82	$\pm 4$	75	100
5	72	$\pm 5$	75	100
6	98	$\pm 3$	45	100
Starting Alarm Value for SPO2: 96% Starting Alarm Value for Rate: 75 BPM Starting Alarm Value for Amplitude: 100% SPO2 Alarm Test: Hi-100% Lo-85% Rate Alarm Test: Hi-140 BPM Lo-50 BPM Asystole Test Amplitude Test Probe Test				

## For CardioSat 100:

SPO2 Autosequence Number: A74				
Autosequence Name: GENERC				
Manufacturer: Generic–Not Specified				
Settling Time: 25 Beats				
Heart Rate Limit: $\pm 4$ BPM (beats per minute)				
Step Number	SPO2 (in percent)	SPO2 Limit (in percent)	Heart Rate (in BPM)	Amplitude (in percent)
1	99	$\pm 4$	250	100
2	96	$\pm 4$	230	100
3	92	$\pm 4$	205	100
4	88	$\pm 5$	180	100
5	78	$\pm 5$	155	100
6	75	$\pm 5$	130	100
7	65	$\pm 6$	105	100
8	55	$\pm 6$	80	100
9	45	$\pm 6$	55	100
10	35	$\pm 6$	30	100
11	90	$\pm 4$	95	100
12	88	$\pm 5$	45	100
13	85	$\pm 5$	130	20
14	92	$\pm 4$	95	40
15	93	$\pm 4$	90	50
Starting Alarm Value for SPO2: 96% Starting Alarm Value for Rate: 75 BPM Starting Alarm Value for Amplitude: 100% SPO2 Alarm Test: Hi–100% Lo–85% Rate Alarm Test: Hi–140 BPM Lo–50 BPM Asystole Test Amplitude Test				

**For the Index 2XL:**

SPO2 Autosequence Number: A70					
Autosequence Name: NELLCR					
Manufacturer: Nellcor					
Settling Time: 25 Beats					
Heart Rate Limit: $\pm 4$ BPM (beats per minute)					
Step Number	SPO2 (in percent)	SPO2 Limit (in percent)	Heart Rate (in BPM)	Amplitude (in percent)	Base TLC
1	96	$\pm 3$	75	6.0	3500
2	98	$\pm 3$	230	6.0	3500
3	81	$\pm 4$	38	2.0	3500
4	81	$\pm 4$	112	6.0	3500
5	81	$\pm 4$	201	6.0	3500
6	92	$\pm 3$	75	6.0	3500
7	82	$\pm 4$	75	6.0	3500
8	72	$\pm 5$	75	6.0	3500
9	98	$\pm 3$	30	6.0	3500
Starting Alarm Value for SPO2: 96% Starting Alarm Value for Rate: 75 BPM Starting Alarm Value for Amplitude: 6.0% SPO2 Alarm Test: Hi-100% Lo-85% Rate Alarm Test: Hi-140 BPM Lo-50 BPM Asystole Test Amplitude Test Probe Test					

SPO2 Autosequence Number: A71					
Autosequence Name: OHMNOV					
Manufacturer: Ohmeda & Nova					
Settling Time: 25 Beats					
Heart Rate Limit: $\pm 4$ BPM (beats per minute)					
Step Number	SPO2 (in percent)	SPO2 Limit (in percent)	Heart Rate (in BPM)	Amplitude (in percent)	Base TLC
1	96	$\pm 3$	75	6.0	3520
2	98	$\pm 3$	230	6.0	3520
3	92	$\pm 3$	75	6.0	3520
4	82	$\pm 4$	75	6.0	3520
5	72	$\pm 5$	75	6.0	3520
6	98	$\pm 3$	45	6.0	3520
Starting Alarm Value for SPO2: 96% Starting Alarm Value for Rate: 75 BPM Starting Alarm Value for Amplitude: 6.0% SPO2 Alarm Test: Hi-100% Lo-85% Rate Alarm Test: Hi-140 BPM Lo-50 BPM Asystole Test Amplitude Test Probe Test					

## For the Index 2XL:

SPO2 Autosequence Number: A72					
Autosequence Name: PMS					
Manufacturer: PMS M1190					
Settling Time: 25 Beats					
Heart Rate Limit: $\pm 4$ BPM (beats per minute)					
Step Number	SPO2 (in percent)	SPO2 Limit (in percent)	Heart Rate (in BPM)	Amplitude (in percent)	Base TLC
1	96	$\pm 3$	75	6.0	3500
2	98	$\pm 3$	230	6.0	3500
3	92	$\pm 3$	75	6.0	3500
4	82	$\pm 4$	75	6.0	3500
5	72	$\pm 5$	75	6.0	3500
6	98	$\pm 3$	45	6.0	3500
Starting Alarm Value for SPO2: 96% Starting Alarm Value for Rate: 75 BPM Starting Alarm Value for Amplitude: 6.0% SPO2 Alarm Test: Hi-100% Lo-85% Rate Alarm Test: Hi-140 BPM Lo-50 BPM Asystole Test Amplitude Test Probe Test					

SPO2 Autosequence Number: A73					
Autosequence Name: DATEX					
Manufacturer: Datex					
Settling Time: 25 Beats					
Heart Rate Limit: $\pm 4$ BPM (beats per minute)					
Step Number	SPO2 (in percent)	SPO2 Limit (in percent)	Heart Rate (in BPM)	Amplitude (in percent)	Base TLC
1	96	$\pm 3$	75	6.0	3030
2	98	$\pm 3$	230	6.0	3030
3	92	$\pm 3$	75	6.0	3030
4	82	$\pm 4$	75	6.0	3030
5	72	$\pm 5$	75	6.0	3030
6	98	$\pm 3$	45	6.0	3030
Starting Alarm Value for SPO2: 96% Starting Alarm Value for Rate: 75 BPM Starting Alarm Value for Amplitude: 6.0% SPO2 Alarm Test: Hi-100% Lo-85% Rate Alarm Test: Hi-140 BPM Lo-50 BPM Asystole Test Amplitude Test Probe Test					



**For the Index 2XL:**

SPO2 Autosequence Number: A74					
Autosequence Name: GENERC					
Manufacturer: Generic–Not Specified					
Settling Time: 25 Beats					
Heart Rate Limit: ± 4 BPM (beats per minute)					
Step Number	SPO2 (in percent)	SPO2 Limit (in percent)	Heart Rate (in BPM)	Amplitude (in percent)	Base TLC
1	99	± 4	250	6.0	4000
2	96	± 4	230	6.0	4000
3	92	± 4	205	6.0	4000
4	88	± 5	180	6.0	4000
5	78	± 5	155	6.0	4000
6	75	± 5	130	6.0	4000
7	65	± 6	105	6.0	4000
8	55	± 6	80	6.0	4000
9	45	± 6	55	6.0	4000
10	35	± 6	30	6.0	4000
11	90	± 4	95	6.0	4000
12	88	± 5	45	6.0	4000
13	85	± 5	130	2.0	4000
14	92	± 4	95	3.0	4000
15	93	± 4	90	4.0	4000
Starting Alarm Value for SPO2: 96% Starting Alarm Value for Rate: 75 BPM Starting Alarm Value for Amplitude: 6.0% SPO2 Alarm Test: Hi–100% Lo–85% Rate Alarm Test: Hi–140 BPM Lo–50 BPM Asystole Test Amplitude Test No probe test included					

## Posttest Prompts

When all tests are completed, the medTester 5000C prompts you for:

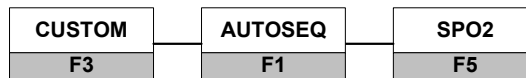
1. COMMENTS
2. NEXT TEST DUE DATE
3. USER TIME **EMS/CMMS system users:** User time is required
4. PRINT TEST TAG
5. STORE or PRINT TEST RECORD

## Customizing SPO2 Autosequences

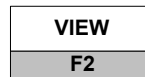
(For detailed information about customizing autosequences, please refer to Chapter 6, *Customize Your medTester 5000C*.)

To begin customizing SPO2 autosequences, you can view any of your current ones by entering these menu commands:

1. From the main menu, MENU1, press the right arrow to access MENU2.
2. Enter the menu commands:



3. From the SPO2 menu, select:
4. Now select the autosequence you want to view.
5. Finally scroll through the steps in the sequence by using your UP and DOWN arrow keys.



## Make Your Own Autosequence

You can customize any of the ten SPO2 autosequences, either the factory preprogrammed or the blank ones. This section describes the menu steps that you use to customize, or create, autosequences. Note that each customized autosequence can include as many as ten SPO2 simulation steps. After you enter the step parameters you want, the medTester prompts you for more steps, if desired. If you do not want further steps in your autosequence, you can press END. Then you can program to include several special tests as desired.

**Note**

You can find detailed information about customizing autosequences in Chapter 6, *Customize Your medTester 5000C*.

**Configuring for Your SPO2 Simulator**

The medTester can only be configured for one type of SPO2 Simulator at a time, either the Oxitest PLUS (including Oxitest PLUS 7), the CardioSat 100 or the Index 2XL. All autosequences stored by initialization, customization, or remote download will only work with the instrument for which they were designed.

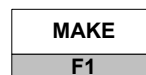
To configure your medTester 5000C, begin by accessing the custom, autosequence, SPO2 menu as described above (Customizing SPO2 Autosequences). This time, select F4 TYPE.

The display shows which SPO2 Simulator is currently selected.

Then select F1 INDEXL or F2 CARDIOSAT or F3 OXITEST+. Then press F5STORE to store the selection. Now, all customized autosequences will be for the designated SPO2 Simulator. After Changing the SPO2 Simulator, you must reinitialize your SPO2 autosequences so that they are compatible with the change. See “Reinitialize Factory Default Settings”( page 230).

**Making an Autosequence**

Begin by accessing the custom, autosequence, SPO2 menu as described above. This time, select:



Next select the name of the autosequence you want to customize or create. Follow the following steps, providing the desired information:

1. Name—This is the name you want to give to the autosequence, with a maximum of six characters.
2. MANUFACTURER: (CardioSat 100 and Index 2XL only) – Select the manufacturer of the pulse oximeter to be tested with F1 DEC and F2 INC. Choose from the manufacturers in the table appropriate for the desired tester below.

CARDIOSAT 100
---------------

Not Specified
BCI
Criticare
Datascope
Datex
Hewlett Packard
Nellcor
Nihon Kohden
Novamatrix
Ohmeda
Respironics

INDEX 2XL	
MANUFACTURER	BASE TLC
Not Specified	4000
BCI	1100
Criticare	1150
Datascope	1024
Datex	3030
PMS M1190	3500
Masimo	4000
Nellcor	3500
Nihon Kohden	1024
Ohmeda & Nova	3520
Respironics	4095
D1 M1191 New	2550
D2 M1191 Old	2550
D3 N-10	2500
D4 Palco 300	2030
D5 Nonin	1000
D6 Invivo	2500

**Note**

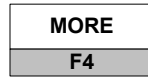
In the table for the Index 2XL, the selections that are prefixed with D1 through D6 are downloadable manufacturer's profiles. The entries for these six profiles are the names and TLC settings used in the Index 2XL. If custom profiles (those used in Autosequences) are downloaded into these locations, the manufacturer's names will not match those on the custom downloads. This discrepancy should be ignored. Program the desired TLC in to the desired Autosequence as it is customized.

**Note**

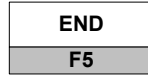
If you choose "Not Specified", you can keep it generic. However, you must manually set the SPO2 simulator to the manufacturer being tested at run time. Press F5 OK to enter your selection.

3. **SETTLING TIME:** Enter the number of heartbeats to wait after starting a simulation, for the pulse oximeter to settle its readings (0-99).
4. **HEART RATE +/- LIMIT:** Enter the limit of variation allowed in Beats Per Minute for heart rates for the SPO2 simulation steps. 00 BPM turns off limit checking.
5. The following parameters can be set for up to 10 SPO2 simulation steps for all analyzers except the Index 2XL, for which 15 steps can be programmed:
  - **SPO2 LEVEL:** Enter the percentage of oxygen saturation desired: For the Oxitest Plus, select from discrete levels of 55%, 70%, 80%, 90%, 93%, and 97%; for the CardioSat 100 and Index 2XL, enter any level from 35% to 100%.
  - **SPO2 +/- LIMIT:** Enter the limit of variation allowed in percent for SPO2 for this SPO2 simulation step. 00% turns off limit checking.
  - **HEART RATE:** Enter the heart rate, for the Oxitest Plus, from 20 to 250 BPM; for the CardioSat 100 and Index 2XL, from 30 to 250 BPM.
  - **AMPLITUDE:** Enter the amplitude in percentage of full amplitude, from 0% to 100%.
  - **TLC (Index 2XL only):** Enter the Transmission Level Control value from 0000 to 4095. The TLC value defaults to the "Base TLC" level for the make of SPO2 manufacturer found in the previous table.
  - **ARTIFACT (Oxitest Plus and Index 2XL only):**
    - For Oxitest the selections are: Off, Movement, Spike or Tremor.
    - For the Index 2XL the selections are: Off, Level 1 or Level 2. Each of these levels contain eight different motion tests. If you choose Level 1 or 2, then you will be prompted to enter the **MOTION TEST SPO2 +/- LIMIT** (defaults to 04%).

After each step selection, you can press



to select more steps, or



to end your selections.

- 6. STARTING ALARM VALUES:** Enter starting values for the alarm tests for:
- SPO2
  - HEART RATE
  - AMPLITUDE (For the Index 2XL, enter amplitude from 0% to 20% with the thirty-three selections offered)

**Note**

Even if you do not intend to perform any alarm tests, you still have to go through the starting alarm values. You can just press ENT to get through them.

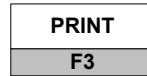
- 7. Answer F4 YES or F5 NO** whether to perform the following special tests:
- SPO2 ALARM TEST: If YES, then enter the Hi and Lo alarm values.
  - RATE ALARM TEST: If YES, then enter the Hi and Lo alarm values.
  - ASYSTOLE TEST
  - AMPLITUDE TEST
  - MOTION TEST (Index 2XL only) – Select the motion test desired.
  - PROBE TEST

After customizing your autosequence, the medTester prompts you to store the autosequence:



**Print Your Autosequence**

From the SPO2 custom autosequences menu described above, printing any autosequence is accomplished through this menu command:

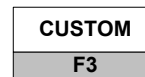


**Reinitialize Factory Default Settings**

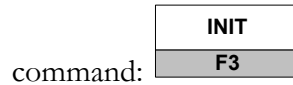
All ten autosequences can be returned to the factory default settings. To do this, enter these medTester commands:

1. From the medTester 5000C main menu, MENU 1, press the right arrow to access MENU 2.

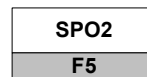
2. Enter the command:



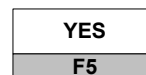
3. From the custom menu, press the right arrow and enter the



4. Choose:



5. To initialize SPO2 autosequences to defaults, press:







# Chapter 16

## **Transcutaneous Pacemaker (Pacer) Module**

*In this chapter you learn about using the medTester 5000C to control transcutaneous pacemaker (pacer) autosequence tests with a Fluke Biomedical transcutaneous pacemaker analyzer, what these tests are, and how to use them.*

### **Pacer Autosequences**

By installing the Pacer module in your medTester 5000C, you have the capability of using a set of 10 autosequences for testing transcutaneous pacemakers with a Fluke Biomedical transcutaneous pacemaker analyzer and collecting test data. The Fluke Biomedical Impulse 4000 connects to the COM2 or designated Wedge port on your medTester which then lets you test the pacers that are on the market today and store test measurements in the medTester 5000C for your equipment management system.

To install the NIBP module, you must first have installed the required prerequisite modules: RS-232/Printer, 100 Records, Expanded Memory, and Data Transfer.

When you connect the Impulse 4000 to your medTester and run pacer autosequences, the medTester displays prompts for your pacer setup and testing and executes tests. The Impulse 4000 returns measurement readings to the medTester, which displays them for you. If you have the medTester 5000C RS-232/Printer module and the Memory module, you can store and print test records.

Having the Pacer module also offers you the ability to incorporate these autosequences into checklists if your medTester 5000C has the medCheck module installed.

For related information, see these chapters in this manual:

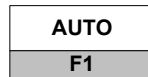
- Chapter 5, *Autosequences*.
- Chapter 6, *Customize Your medTester 5000C*—for customizing autosequences.
- Chapter 8, *Memory*—for test record storage and printing.

**Note**

Consult your Impulse 4000 operators manual for proper operation.

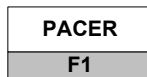
To discover if you have the Pacer module installed on your medTester 5000C, enter these menu commands:

1. From the main menu, MENU1, press:



to reach the autosequences menu.

2. Press the right arrow to access additional autosequence types



3. Press:

If pacer autosequences are installed, you see this message displayed:

SELECT PACER AUTOSEQUENCE TO RUN

The autosequence names appear below the message. To begin working with these autosequences, look at the table of pacer autosequence names.

If the Pacer module has not been installed, this message appears on the display:

MODULE NOT INSTALLED

If the module was installed and you get this message, it may be necessary to re-enable the module. Refer to the “Enabling Modules” section of Chapter 2 – Installation.

### Pacer Autosequence Names

You can begin any of the autosequences listed below from the medTester menu commands or by entering the keyboard shortcut command directly into the medTester. You can also include pacer autosequences as checkitems in checklists. For more information about checklists, see Chapter 11, *medCheck Module*. See Chapter 12, *Remote Operation*, for information about remote mode of operation.

PACER AUTOSEQUENCES		
Autosequence Name	Keyboard Shortcut Command	Menu Commands From the autosequence (AUTO) menu press the right arrow, and then press:
		<div style="border: 1px solid black; padding: 2px; margin: 0 auto; width: 60px;">PACER</div> <div style="border: 1px solid black; padding: 2px; margin: 0 auto; width: 60px;">F1</div>
LP12P	A20	<div style="border: 1px solid black; padding: 2px; margin: 0 auto; width: 60px;">LP12P</div> <div style="border: 1px solid black; padding: 2px; margin: 0 auto; width: 60px;">F1</div>
LP9PM	A21	<div style="border: 1px solid black; padding: 2px; margin: 0 auto; width: 60px;">LP9PM</div> <div style="border: 1px solid black; padding: 2px; margin: 0 auto; width: 60px;">F2</div>
HPCMPM6	A22	<div style="border: 1px solid black; padding: 2px; margin: 0 auto; width: 60px;">HPCMPM</div> <div style="border: 1px solid black; padding: 2px; margin: 0 auto; width: 60px;">F3</div>
MDE3PM	A23	<div style="border: 1px solid black; padding: 2px; margin: 0 auto; width: 60px;">MDE3PM</div> <div style="border: 1px solid black; padding: 2px; margin: 0 auto; width: 60px;">F4</div>
ZOLLPM	A24	<div style="border: 1px solid black; padding: 2px; margin: 0 auto; width: 60px;">ZOLLPM</div> <div style="border: 1px solid black; padding: 2px; margin: 0 auto; width: 60px;">F5</div>
blank (user-defined)	A25-A29	(from the next menu, press the right arrow)  <div style="border: 1px solid black; padding: 2px; margin: 0 auto; width: 60px;">blank</div> <div style="border: 1px solid black; padding: 2px; margin: 0 auto; width: 60px;">F1-F5</div>

## Running Pacer Autosequence Tests

To begin running pacer autosequence tests, connect your medTester 5000C to your Impulse 4000. These two instruments are connected through the COM2 or Wedge port on the medTester and the RS-232 serial port on the Impulse 4000.

### Note

Refer to Chapter 1, *General Information – Accessories*, or the current Fluke Biomedical Price List for the correct serial cable part number needed.

From the medTester 5000C Pacer menu, select the autosequence name for the autosequence you wish to run. The name and number of the selected autosequence appears on the display followed by the prompt:

Press F5 for all device info prompts

If a safety autosequence has executed since power up of the medTester, you can have the medTester use the previously input prompt information for the current pacer autosequence, from this prompt:

USE PREVIOUS STARTING INFORMATION?

YES	NO
F1	F2

To accept previously input prompt information, press YES, and go to *Test Sequence*, which follows this section. If you choose NO, go to the prompt instructions in *Pretest Device Prompts*.

### Pretest Device Prompts

There are eight prompts for information that can appear in the autosequence test record. After selecting the desired autosequence, the medTester 5000C prompts you to enter device prompts. If you have some or all prompts turned off, the autosequence still gives you the brief opportunity to enter device information at the test's initiation with the message:

Press F5 for all device info prompts

1. **OP CODE**—This is the operator code for the person doing the testing. This code can consist of a maximum of three characters which can be entered from the medTester keyboard. An example of an operator code could be a person's initials or employee number. The previous operator's code, if any, will appear. If the current operator has not changed from previous use, press the ENT key.
2. **TYPE**—Enter the device name, code, or other descriptor for the equipment under test. This entry can be a maximum of 16 characters.
3. **MANF**—Enter the name of the device manufacturer, 16 characters maximum.
4. **LOC**—Type in the location of the device, 16 characters maximum. The previous location, if any, will appear. If this occurs and is the desired location, press the ENT key.
5. **MODEL**—Enter the device model number, 16 characters maximum.
6. **SERIAL #**—Type the device serial number, again 16 characters maximum.
7. **CONTROL #**—Enter a control number with a maximum of 16 characters.
8. **PHYSICAL INSPECTION**—You have two physical inspection lines, each of which can consist of a maximum of 40 characters. After entering data for the first prompt, the second prompt appears.

**Note**

See Chapter 5, *Autosequences*, for a complete explanation of working with prompts. You can turn individual prompts on or off and rename prompts six through eight (6-8) from the list above. Chapter 6, *Customize Your medTester 5000C*, explains how to customize prompts.

**Test Sequence**

After you input pretest prompt information, pacer tests execute in the order described below:

Set the Impulse 4000 serial port baud rate to 2400. The medTester uses the 2400 baud rate on COM2 or designated Wedge port for all communications with the Impulse 4000 during an autosequence.

The Impulse 4000 must be powered up to one of its main menus to be ready to accept remote commands from a medTester Pacer autosequence.

At the beginning of a Pacer autosequence, the medTester checks to make sure that an Impulse 4000 is connected to COM2. If none is detected, you can still go through the sequence in a simulation mode for demonstration purposes.

Each autosequence can contain up to ten pulse tests. After those, several special tests will be performed if they have been programmed into the autosequence.

The Pacer autosequences are designed to make measurements with either the internal 50 ohm test load or via a specified external TQA module. The specified test load must be used to continue the autosequence.

The factory pre-programmed autosequences also use the internal 50 ohm test load and the external TQA modules. The Pacer autosequence names are coded with an “M” suffix if a TQA module is required for the particular autosequence. A22 (HPCMPM) is designed for the Hewlett-Packard Code Master Pacer and the TQA12 module is required. A20 (LP12P) is designed for the Phys-Control Life Pak 12 Pacer using the internal 50 ohm test load.

### **Pulse Tests**

For each of the pulse test steps, 1 through 10, the medTester prompts you through the step and controls the Impulse 4000 to perform the test.

First, the medTester prompts you to set up the transcutaneous pacemaker to the programmed pacer current and pacing rate. When ready, press F5 READY.

The medTester gets a pulse measurement from the Impulse 4000 every 5 seconds and displays the pulse current, rate, and width. The medTester compares the pulse current and rate values to the autosequence programmed limits. Any out of limit values are flagged with a “#” to denote the out of limit condition.

#### **Note**

In order to flag the applied pacer out-of-limit values, the following conditions and limits must be exceeded:  
Pulse current: Measured values in milliamperes (mA) must differ from the nominal setting by more than the  $\pm$  % value and by more than 5 milliamperes (mA).  
Pulse rate: Measured values in pulses per minute (PPM) must differ by more than the programmed limit (in PPM).

When you are ready to accept the test data, press F5 HOLD to hold it.

If there are any out of limit values, each one is displayed in its own menu screen. Press F5 CONTINUE to accept the data into the test record or F4 REPEAT to repeat the pulse test step.

After the out of limit messages, the medTester displays the complete test data. Press F5 CONTINUE to accept the data into the test record or F4 REPEAT to repeat the pulse test step.

Any out of limit value which is accepted for the test record will be stored with a ‘#’ which will indicate that the test record contains a failed test.

### **Demand Test**

The demand test checks that in the demand mode, the pacer will pulse interactively with ECG waveforms at different rates. The demand test requires that the pacer is in the demand mode and that the pacer ECG monitor leads are connected to the ECG posts of the Impulse 4000.

### **Underdrive**

The demand underdrive test checks to make sure the pacer outputs pacing pulses when the ECG signal is too slow to sustain a patient without pacing.

The medTester displays the pacing rate and the underdrive ECG rate. Set the pacer to demand mode at the pacing rate and turn on pacing. Press F5 START.

The medTester turns on the ECG waveform on the Impulse 4000.

The medTester indicates that pacing should be on. Observe the pacer ECG monitor to check that the ECG signal is running and that pacing is on.

Press F4 PASS or F5 FAIL to store that with the record. FAIL is stored with a “#”.

### **Overdrive**

The demand overdrive test checks to make sure the pacer does not output pacing pulses when the ECG signal is fast enough that the patient does not need to be paced.

The medTester displays the pacing rate and the overdrive ECG rate. Set the pacer to demand mode at the pacing rate and turn on pacing. Press F5 START.

The medTester turns on the ECG waveform on the Impulse 4000.

The medTester indicates that pacing should be off. Observe the pacer ECG monitor to check that the ECG signal is running and that pacing is off.

Press F4 PASS or F5 FAIL to store that with the record. FAIL is stored with a “#”.



### **Async Test**

The async test checks that in the asynchronous, or non-demand, mode, the pacer will pulse correctly even with an ECG waveform at a high rate. The async test requires that the pacer is in the async mode and that the pacer ECG monitor leads are connected to the ECG posts of the Impulse 4000.

The medTester displays the pacing rate and the overdrive ECG rate. Set the pacer to async mode at the pacing rate and turn on pacing. Press F5 START.

The medTester turns on the ECG waveform on the Impulse 4000.

The medTester indicates that pacing should be on. Observe the pacer ECG monitor to check that the ECG signal is running and that pacing is on. During this test, the ECG signal and pacer activity could coincide.

Press F4 PASS or F5 FAIL to store that with the record. FAIL is stored with a “#”.

### **Refractory Period Test**

The refractory period test measures the refractory period of the pacer in the demand mode. They are:

- PRP Pulsed refractory period
- SRP Sensed refractory period

Refer to the Impulse 4000 Operators Manual for definitions of the refractory periods.

The refractory period test requires that the pacer is in the demand mode and that the pacer ECG monitor leads are connected to the ECG posts of the Impulse 4000.

Set the pacer to the demand mode and turn on pacing at the desired rate. Press F5 START. Wait for the test to be completed.

When finished the medTester displays the test results: PRP, SRP, and pacing rate. Press F5 CONTINUE to accept the results into the test record or F4 REPEAT to repeat the test.

<b>Pacer Autosequence Number: A20</b>		
<b>Autosequence Name: LP12P</b>		
<b>Load: Internal 50 Ohms</b>		
<b>Step Number</b>	<b>Current (in milliamperes)</b>	<b>Rate (in PPM, pulses per minute)</b>
1	10	40
2	10	60
3	50	60
4	100	60
5	150	60
6	200	60
7	200	40
8	200	170
<b>Pulse Tests:</b> <ul style="list-style-type: none"><li>•Current Limit: <math>\pm 20\%</math></li><li>•Rate Limit: <math>\pm 5</math> PPM</li></ul> <b>Demand Test: 80 PPM</b> <ul style="list-style-type: none"><li>•Underdrive: 30 BPM</li><li>•Ovedrive: 160 BPM</li></ul> <b>Async Test: No</b> <b>Refractory Period Test: No</b>		

Pacer Autosequence Number: A21		
Autosequence Name: LP9PM		
Load: Adapter Module TQA-16, External 700 Ohms		
Step Number	Current (in milliamperes)	Rate (in PPM, pulses per minute)
1	55	170
2	55	160
3	55	150
4	55	140
5	55	130
6	55	120
7	55	110
8	55	100
9	55	90
10	55	80
11	55	70
12	55	60
13	55	50
14	55	40
15	200	60
16	150	60
17	130	60
18	100	60
<b>Pulse Tests:</b> <ul style="list-style-type: none"> <li>• Current Limit: <math>\pm 20\%</math></li> <li>• Rate Limit: <math>\pm 5</math> PPM</li> </ul> <b>Demand Test: 60 PPM</b> <ul style="list-style-type: none"> <li>• Underdrive: 30 BPM</li> <li>• Overdrive: 160 BPM</li> </ul> <b>Async Test: 60 PPM</b> <ul style="list-style-type: none"> <li>• Overdrive: 160 BPM</li> </ul> <b>Refractory Period Test: No</b>		

Pacer Autosequence Number: A22		
Autosequence Name: HPCMPM		
Load: Adapter Module TQA-12, External 400 Ohms		
Step Number	Current (in milliamperes)	Rate (in PPM, pulses per minute)
1	30	40
2	30	50
3	30	60
4	30	70
5	30	80
6	30	90
7	30	100
8	30	110
9	30	120
10	30	130
11	30	140
12	30	150
13	30	160
14	30	170
15	30	180
16	60	80
17	100	80
18	140	80
19	180	80
20	200	80
<b>Pulse Tests:</b> <ul style="list-style-type: none"> <li>•Current Limit: <math>\pm 20\%</math></li> <li>•Rate Limit: <math>\pm 5</math> PPM</li> </ul> <b>Demand Test: 80 PPM</b> <ul style="list-style-type: none"> <li>•Underdrive: 30 BPM</li> <li>•Overdrive: 160 BPM</li> </ul> <b>Async Test: 80 PPM</b> <ul style="list-style-type: none"> <li>•Overdrive: 160 BPM</li> </ul> <b>Refractory Period Test: No</b>		

Step Number	Current (in milliamperes)	Rate (in PPM, pulses per minute)
1	60	40
2	60	60
3	60	70
4	60	75
5	60	80
6	60	90
7	60	100
8	60	120
9	60	140
10	60	160
11	120	60
12	90	100
13	120	100
<b>Pulse Tests:</b> <ul style="list-style-type: none"> <li>• Current Limit: <math>\pm 20\%</math></li> <li>• Rate Limit: <math>\pm 5</math> PPM</li> </ul> <b>Demand Test: 80 PPM</b> <ul style="list-style-type: none"> <li>• Underdrive: 30 BPM</li> <li>• Overdrive: 160 BPM</li> </ul> <b>Async Test: 80 PPM</b> <ul style="list-style-type: none"> <li>• Overdrive: 160 BPM</li> </ul> <b>Refractory Period Test: No</b>		

Pacer Autosequence Number: A24		
Autosequence Name: ZOLLPM		
Load: Adapter Module TQA-2, External 1000 Ohms		
Step Number	Current (in milliamperes)	Rate (in PPM, pulses per minute)
1	80	180
2	80	160
3	80	140
4	80	120
5	80	100
6	80	80
7	80	60
8	80	40
9	140	80
10	100	80
11	60	80
12	20	80
<b>Pulse Tests:</b> <ul style="list-style-type: none"> <li>•Current Limit: <math>\pm 20\%</math></li> <li>•Rate Limit: <math>\pm 5</math> PPM</li> </ul> <b>Demand Test: 80 PPM</b> <ul style="list-style-type: none"> <li>•Underdrive: 30 BPM</li> <li>•Ovedrive: 160 BPM</li> </ul> <b>Async Test: No</b> <b>Refractory Period Test: No</b>		

### Posttest Prompts

When all tests are completed, the medTester 5000C prompts you for:

1. COMMENTS
2. NEXT TEST DUE DATE
3. USER TIME **EMS/CMMS system users:** User time is required
4. PRINT TEST TAG
5. STORE or PRINT TEST RECORD

## Customizing Pacer Autosequences

(For detailed information about customizing autosequences, please refer to Chapter 6, *Customize Your medTester 5000C*.)

To begin customizing pacer autosequences, you can view any of your current ones by entering these menu commands:

1. From the main menu, MENU1, press the right arrow to access MENU2.

2. Enter the menu commands:
 

CUSTOM
F3

AUTOSEQ
F1

3. Press the right arrow, and then press:
 

PACER
F1

4. From the PACER menu, select:
 

VIEW
F2

5. Now select the autosequence you want to view.
6. Finally scroll through the steps in the sequence by using your up and down arrow keys.

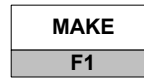
### Make Your Own Autosequence

You can customize the 5 preprogrammed pacer autosequences or create 5 new ones with the **blank** sequences. This section describes the menu steps that you use to customize, or create, autosequences. Note that each customized autosequence can include as many as 20 pulse test steps. After you enter the pulse test values you want, the medTester prompts you for more pulse test steps, if desired. If you do not want further pulse test steps in your autosequence, you can press **END**.

**Note**

You can find detailed information about customizing autosequences in Chapter 6, *Customize Your medTester 5000C*.

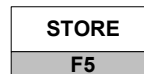
Begin by accessing the custom, autosequence, pacer menu as described earlier. This time, select:



Next select the name of the autosequence you want to customize or create. Follow the following steps, providing the desired information:

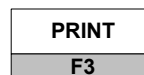
- 1.** Name—This is the name you want to give to the autosequence, with a maximum of six characters.
  
- 2.** Menu Steps:
  - Load: Select internal 50 ohms or a TQA module
  - Pulse tests, 20 steps:
    - Current: 10 to 250 mA
    - Pulse Rate: 30 to 200 PPM
    - Load, if using a multiple test load TQA module
  - Current +/- limit: 0 to 99% (0% is off)
  - Pulse Rate +/- limit: 0 to 99 PPM (0 is off)
  - Demand Test:
    - Pacer Rate: 30 to 200 PPM
    - Underdrive ECG Rate: 30, 60, 80, 120, or 160 BPM
    - Overdrive ECG Rate: 60, 80, 120, 160, or 200 BPM
  - Async Test:
    - Pacer Rate: 30 to 200 PPM
    - Overdrive ECG Rate: 60, 80, 120, 160, or 200 BPM
  - Refractory Period Test

After customizing your autosequence, the medTester prompts you to store the autosequence:



**Print Your Autosequence**

From the pacer custom autosequences menu described above, printing any autosequence is accomplished through this menu command:



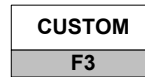


### Reinitialize Factory Default Settings

Any customized autosequences can be returned to the factory default settings. To do this, enter these medTester commands:

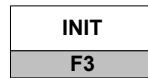
1. From the medTester 5000C main menu, MENU1, press the right arrow to access MENU2.

2. Enter the command:

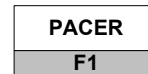


3. From the custom menu, press the right arrow and enter the

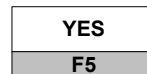
command:



4. Press the right arrow, and then press:



5. To initialize pacer autosequences to defaults, press:





# Chapter 17

## **Non-Invasive Blood Pressure (NIBP) Module**

*In this chapter you learn about using the medTester 5000C to control non-invasive blood pressure (NIBP) autosequence tests with a Fluke Biomedical NIBP analyzer, what these tests are, and how to use them.*

### **NIBP Autosequences**

By installing the NIBP module in your medTester 5000C, you have the capability of using a set of 10 autosequences for testing NIBP monitors using the Fluke Biomedical CuffLink NIBP analyzer to collect test data. The Fluke Biomedical CuffLink connects to the COM2 or designated wedge port on your medTester which then lets you test the NIBP monitors that are on the market today and store test measurements in the medTester 5000C for printout or upload to your equipment management system.

To install the NIBP module, you must first have installed the required prerequisite modules: RS-232/Printer, 100 Records, Expanded Memory, and Data Transfer.

When you connect the CuffLink to your medTester and run NIBP autosequences, the medTester displays prompts for your NIBP setup and testing and then executes the prescribed tests. The CuffLink returns measurement readings to the medTester, which displays them for you. If you have the medTester 5000C RS-232/Printer module and the Memory module, you can store and print test records.

Having the NIBP module also offers you the ability to incorporate these autosequences into checklists if your medTester 5000C has the medCheck module installed.

For related information, see these chapters in this manual:

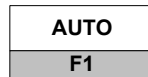
- Chapter 5, *Autosequences*.
- Chapter 6, *Customize Your medTester 5000C*—for customizing autosequences.
- Chapter 8, *Memory*—for test record storage and printing.

**Note**

Consult your CuffLink operating manual for proper operation.

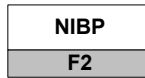
To discover if you have the NIBP module installed on your medTester 5000C, enter these menu commands:

1. From the main menu, MENU1, press:



to reach the autosequences menu.

2. Press the right arrow to access additional autosequence types



3. Press:

If NIBP autosequences are installed, you see this message displayed:

SELECT NIBP AUTOSEQUENCE TO RUN

The autosequence names appear below the message. To begin working with these autosequences, look at the table of pacer autosequence names.

If the Pacer module has not been installed, this message appears on the display:

MODULE NOT INSTALLED

If the module was installed and you get this message, it may be necessary to re-enable the module. Refer to the “Enabling Modules” section of Chapter 2 – Installation.

### **NIBP Autosequence Names**

You can begin any of the autosequences listed below from the medTester menu commands or by entering the keyboard shortcut command directly into the medTester. You can also include NIBP autosequences as checkitems in checklists. For more information about checklists, see Chapter 11, *medCheck Module*. See Chapter 12, *Remote Operation*, for information about remote mode of operation.

<b>NIBP AUTOSEQUENCES</b>				
Autosequence Name	Keyboard Shortcut Command	Menu Commands From the autosequence (AUTO) menu press the right arrow, and then press:		
		<table border="1" style="margin: auto;"> <tr><td style="text-align: center;"><b>NIBP</b></td></tr> <tr><td style="text-align: center;"><b>F2</b></td></tr> </table>	<b>NIBP</b>	<b>F2</b>
<b>NIBP</b>				
<b>F2</b>				
ADULT1	A80	<table border="1" style="margin: auto;"> <tr><td style="text-align: center;"><b>ADULT1</b></td></tr> <tr><td style="text-align: center;"><b>F1</b></td></tr> </table>	<b>ADULT1</b>	<b>F1</b>
<b>ADULT1</b>				
<b>F1</b>				
ADULT2	A81	<table border="1" style="margin: auto;"> <tr><td style="text-align: center;"><b>ADULT2</b></td></tr> <tr><td style="text-align: center;"><b>F2</b></td></tr> </table>	<b>ADULT2</b>	<b>F2</b>
<b>ADULT2</b>				
<b>F2</b>				
ADULT3	A82	<table border="1" style="margin: auto;"> <tr><td style="text-align: center;"><b>ADULT3</b></td></tr> <tr><td style="text-align: center;"><b>F3</b></td></tr> </table>	<b>ADULT3</b>	<b>F3</b>
<b>ADULT3</b>				
<b>F3</b>				
NEONT1	A83	<table border="1" style="margin: auto;"> <tr><td style="text-align: center;"><b>NEONT1</b></td></tr> <tr><td style="text-align: center;"><b>F4</b></td></tr> </table>	<b>NEONT1</b>	<b>F4</b>
<b>NEONT1</b>				
<b>F4</b>				
NEONT2	A84	<table border="1" style="margin: auto;"> <tr><td style="text-align: center;"><b>NEONT2</b></td></tr> <tr><td style="text-align: center;"><b>F5</b></td></tr> </table>	<b>NEONT2</b>	<b>F5</b>
<b>NEONT2</b>				
<b>F5</b>				
blank (user-defined)	A85-A89	<table border="1" style="margin: auto;"> <tr><td style="text-align: center;"><b>blank</b></td></tr> <tr><td style="text-align: center;"><b>F3-F5</b></td></tr> </table>	<b>blank</b>	<b>F3-F5</b>
<b>blank</b>				
<b>F3-F5</b>				

## Running NIBP Autosequence Tests

To begin running NIBP autosequence tests, connect your medTester 5000C to your CuffLink. These two instruments are connected through the COM2 or designated wedge port on the medTester and the RS-232 serial port on the CuffLink.

### Note

Refer to Chapter 1, *General Information - Accessories*, or the current Fluke Biomedical Price List for the correct serial cable part number needed.

From the medTester 5000C NIBP menu, select the autosequence name for the autosequence you wish to run. The name and number of the selected autosequence appears on the display followed by the prompt:

Press F5 for all device info prompts

If a safety autosequence has executed since power up of the medTester, you can have the medTester use the previously input prompt information for the current pacer autosequence, from this prompt:

USE PREVIOUS STARTING INFORMATION?

YES	NO
F1	F2

To accept previously input prompt information, press YES, and go to *Test Sequence*, which follows this section. If you choose NO, go to the prompt instructions in *Pretest Device Prompts*.

## Pretest Device Prompts

There are eight prompts for information that can appear in the autosequence test record. After selecting the desired autosequence, the medTester 5000C prompts you to enter device prompts. If you have some or all prompts turned off, the autosequence still gives you the opportunity to enter device information with the message:

Press F5 for all device info prompts

1. **OP CODE**—This is the operator code for the person doing the testing. This code can consist of a maximum of three characters which can be entered from the medTester keyboard. An example of an operator code could be a person's initials or employee number. The previous operator's code, if any, will appear. If the current operator has not changed from previous use, press the ENT key. **Sentinel users:** Substitute TECH CODE. This is required for closing work orders.
2. **TYPE**—Enter the device name, code, or other descriptor for the equipment under test. This entry can be a maximum of 16 characters.
3. **MANF**—Enter the name of the device manufacturer, 16 characters maximum.
4. **LOC**—Type in the location of the device, 16 characters maximum. The previous location, if any, will appear. If this occurs and is the desired location, press the ENT key.
5. **MODEL**—Enter the device model number, 16 characters maximum.
6. **SERIAL #**—Type the device serial number, again 16 characters maximum.
7. **CONTROL #**—Enter a control number with a maximum of 16 characters. **Sentinel users:** Use the control number found in the equipment record.
8. **PHYSICAL INSPECTION**—You have two physical inspection lines, each of which can consist of a maximum of 40 characters. After entering data for the first prompt, the second prompt appears.

**Note**

See Chapter 5, *Autosequences*, for a complete explanation of working with prompts. You can turn individual prompts on or off and rename prompts six through eight (6-8) from the list above. Chapter 6, *Customize Your medTester 5000C*, explains how to customize prompts.

**Test Sequence**

After you input pretest prompt information, NIBP tests execute in the order described below:

Set the CuffLink serial port baud rate to 2400. The medTester uses the 2400 baud rate on COM2 for all communications with the CuffLink during an autosequence.

At the beginning of an NIBP autosequence, the medTester checks to make sure that a CuffLink is connected to COM2. If none is detected, you can still go through the sequence in a simulation mode for demonstration purposes.

Each autosequence can contain up to ten NIBP tests. After those, several special tests will be performed if they have been programmed into the autosequence.

**NIBP TESTS**

For each of the NIBP test steps, 1 through 10, the medTester prompts you through the step and controls the CuffLink to perform the test.

First, the medTester sets up the CuffLink for the test and displays the test parameters:

- Step No.
- Basic Blood Pressure Target Value
- Envelope shift
- Heart Rate
- Envelope Gain

The medTester prompts you to “RUN NIBP MEASUREMENT”. You should ensure that the NIBP monitor is correctly connected to the CuffLink and then run the measurement.

When the medTester detects that the measurement is complete, it displays “CuffLink DONE”. If satisfied that the test was good, you can then press F5 “CONTINUE” or if not, press F4 “REPEAT” to repeat the test.



The medTester records the following test parameters from the CuffLink for the test record:

- Peak Pressure
- Total Time
- Inflation Rate and Time
- Deflation Rate and Time

You should now observe the blood pressure and heart rate readings displayed on the NIBP monitor. You can enter test results in two ways:

1. You can make a judgment yourself and press F1 PASS or F2 FAIL to store that with the record. FAIL is stored with a “#”.
2. Or you can press F3 DATA to enter the actually observed NIBP monitor readings into the medTester using the numeric, UP/DOWN, and LEFT/RIGHT keys, followed by ENT to complete. Enter the data below the nominal values. Note that if there was an envelope shift, the medTester display of nominal blood pressures now includes that shift. Now the medTester will compare entered data to the autosequence programmed limits for blood pressure and heart rate. If any values are out of limits, the medTester displays a message which flags that value with a “#” and states the out of limit condition. You may then accept the value or may repeat the test.

Any out of limit value which is accepted for the test record will be stored with a “#” which will indicate that the test record contains a failed test.

**Note**

Refer to the operating or service manual of the NIBP monitor to be inspected for the suitability of the autosequences’ PRESSURE TEST, LEAK TEST, and POPOFF TEST. These CuffLink pressure tests require that the NIBP monitor must be able to close its pneumatic cuff circuit during the test sequence. If the NIBP monitor has its own pressure test, leak test, or popoff test; run them in lieu of the prescribed CuffLink tests.

### **PRESSURE TEST**

The pressure test allows you to document up to three static pressure levels generated by the CuffLink. You can then compare the NIBP monitor reading. You can press F1 **START** to start one of the three pressure test steps or F2 **SKIP** to skip a step.

To perform a pressure test the NIBP monitor must be set to a mode where it continuously reads and displays the pressure and closes the cuff circuit to the outside air.

On starting a pressure test, initially the medTester commands the CuffLink to inflate up to 200 mmHg. Then it continuously reads the pressure from the CuffLink. You can adjust the pressure by pressing F1 **RELEASE** to release all pressure back to zero, F2 **200** to inflate the pressure back up to 200 mmHg, or F3 **+25** to inflate the pressure to 25 mmHg higher than the last reading.

You should compare the NIBP monitor pressure reading with the medTester reading (from the CuffLink). When you have a reading you want to store into the test record, press F5 **STORE**. You should be watching the NIBP monitor pressure reading just as you press F5 **STORE**.

As before in the NIBP tests you can enter test results in two ways:

1. You can make a judgment yourself and press F1 **PASS** or F2 **FAIL** to store that with the record. **FAIL** is stored with a “#”.
2. Or you can press F3 **DATA** to enter the actually observed NIBP monitor pressure reading into the medTester using the numeric, **UP/DOWN**, and **LEFT/RIGHT** keys, followed by **ENT** to complete. Enter the data below the nominal value.

Or press F4 **REPEAT** to repeat that pressure test step.

### **LEAK TEST**

The leak test measures the rate of leakage in the NIBP measurement system after it is inflated to a fixed pressure level.

Press F1 **START** to start the leak test.

On starting a leak test, initially the medTester commands the CuffLink to inflate up to 200 mmHg. Then it continuously reads the pressure from the CuffLink. Adjust the pressure to the value where you would like to start the leak test. You can adjust the pressure by pressing F1 **RELEASE** to release all pressure back to zero, F2 **200** to inflate the pressure back up to 200 mmHg, or F3 **+25** to inflate the pressure to 25 mmHg higher than the last reading.

When you have adjusted the pressure to your desired leak test start pressure, press F5 **START**.

The medTester continuously reads and displays the CuffLink pressure and also the duration of the leak test in minutes and seconds.

Press F5 **END** to end the leak test.

The medTester displays the leak rate in mmHg/minute. Press F5 **CONTINUE** to accept the test or F4 **REPEAT** to repeat the test.

### **POP OFF TEST**

The pop off test measures how much pressure is required to pop off, or activate, the pressure release safety valve of the NIBP monitor.

Press F1 **START** to start the pop off test.

On starting a pop off test, initially the medTester commands the CuffLink to inflate up to 200 mmHg. From there, it increments the pressure by 10 mmHg, up to a maximum of 500 mmHg, until the pressure in the system drops, indicating that the pressure release valve has opened.

Press F5 **END** to end the pop off test.

The medTester displays the pop off pressure. Press F5 **CONTINUE** to accept the test or F4 **REPEAT** to repeat the test.

NIBP Autosequence Number: A80				
Autosequence Name: ADULT1				
Step Number	Blood Pressure	Heart Rate in BPM (beats per minute)	Envelope Gain	Envelope Shift
1	120/80 (90) ADULT	80	100%	+0
2	80/50 (62) ADULT	45	100%	+0
3	150/100 (115) ADULT	125	100%	+0
<b>NIBP Test Limits:</b> <ul style="list-style-type: none"> <li>• NIBP: <math>\pm 20\%</math></li> <li>• Heart Rate: <math>\pm 4</math> BPM</li> </ul> <b>Pressure Test: No</b> <b>Leak Test: No</b> <b>Pop Off Test: No</b>				

NIBP Autosequence Number: A81				
Autosequence Name: ADULT2				
Step Number	Blood Pressure	Heart Rate in BPM (beats per minute)	Envelope Gain	Envelope Shift
1	120/80 (90) ADULT	80	100%	+0
2	80/50 (62) ADULT	45	100%	+0
3	150/100 (115) ADULT	125	100%	+0
<b>NIBP Test Limits:</b> <ul style="list-style-type: none"> <li>• NIBP: <math>\pm 20\%</math></li> <li>• Heart Rate: <math>\pm 4</math> BPM</li> </ul> <b>Pressure Test: Yes</b> <b>Leak Test: Yes</b> <b>Pop Off Test: Yes</b>				

NIBP Autosequence Number: A82				
Autosequence Name: ADULT3				
Step Number	Blood Pressure	Heart Rate in BPM (beats per minute)	Envelope Gain	Envelope Shift
1	120/80 (90) ADULT	80	100%	+0
2	80/50 (62) ADULT	80	100%	+0
3	150/100 (115) ADULT	80	100%	+0
4	120/80 (90) ADULT	45	100%	+0
5	120/80 (90) ADULT	125	100%	+0
6	200/150 (165) ADULT	200	100%	+0
7	120/80 (90) AFIB	N/A	N/A	N/A
8	120/80 (90) PAC	N/A	N/A	N/A
<b>NIBP Test Limits:</b> <ul style="list-style-type: none"> <li>• NIBP: <math>\pm 20\%</math></li> <li>• Heart Rate: <math>\pm 4</math> BPM</li> </ul> <b>Pressure Test: Yes</b> <b>Leak Test: Yes</b> <b>Pop Off Test: Yes</b>				

NIBP Autosequence Number: A83				
Autosequence Name: NEONT1				
Step Number	Blood Pressure	Heart Rate in BPM (beats per minute)	Envelope Gain	Envelope Shift
1	80/50 (62) NEONT	120	100%	+0
2	60/30 (40) NEONT	80	100%	+0
3	100/65 (75) NEONT	180	100%	+0
<b>NIBP Test Limits:</b> <ul style="list-style-type: none"> <li>• NIBP: <math>\pm 20\%</math></li> <li>• Heart Rate: <math>\pm 6</math> BPM</li> </ul> <b>Pressure Test: No</b> <b>Leak Test: No</b> <b>Pop Off Test: No</b>				

NIBP Autosequence Number: A84				
Autosequence Name: NEONT2				
Step Number	Blood Pressure	Heart Rate in BPM (beats per minute)	Envelope Gain	Envelope Shift
1	80/50 (62) NEONT	120	100%	+0
2	60/30 (40) NEONT	80	100%	+0
3	100/65 (75) NEONT	180	100%	+0
<b>NIBP Test Limits:</b> <ul style="list-style-type: none"> <li>• NIBP: <math>\pm 20\%</math></li> <li>• Heart Rate: <math>\pm 6</math> BPM</li> </ul> <b>Pressure Test: Yes</b> <b>Leak Test: Yes</b> <b>Pop Off Test: Yes</b>				

### Posttest Prompts

When all tests are completed, the medTester 5000C prompts you for:

1. COMMENTS
2. NEXT TEST DUE DATE
3. USER TIME **EMS/CMMS system users:** User time is required.
4. PRINT TEST TAG
5. STORE or PRINT TEST RECORD

## Customizing NIBP Autosequences

(For detailed information about customizing autosequences, please refer to Chapter 6, *Customize Your medTester 5000C*.)

To begin customizing NIBP autosequences, you can view any of your current ones by entering these menu commands:

1. From the main menu, MENU1, press the right arrow to access MENU2.

2. Press the menu commands: 

CUSTOM	AUTOSEQ
F3	F1

3. Press the right arrow, and then press: 

NIBP
F2

4. From the NIBP menu, select: 

VIEW
F2

5. Now select the autosequence you want to view.
6. Finally scroll through the steps in the sequence by using your up and down arrow keys.

### Make Your Own Autosequence

You can customize the 5 preprogrammed pacer autosequences or create 5 new ones with the blank sequences. This section describes the menu steps that you use to customize, or create, autosequences. Note that each customized autosequence can include as many as 10 NIBP tests. After you enter the NIBP test values you want, the medTester prompts you for more NIBP test steps, if desired. If you do not want further NIBP test steps in your autosequence, you can press END.

#### Note

You can find detailed information about customizing autosequences in Chapter 6, *Customize Your medTester 5000C*.

Begin by accessing the custom, autosequence, NIBP menu as described earlier. This time, select:



Next select the name of the autosequence you want to customize or create. Follow the following steps, providing the desired information:

**1.** Name—This is the name you want to give to the autosequence, with a maximum of six characters.

**2.** Menu Steps:

- NIBP Tests, 10 steps:

NIBP selection:

60/ 30( 40) ADULT  
 80/ 50( 62) ADULT  
 100/ 65( 75) ADULT  
 120/ 80( 90) ADULT  
 150/100(115) ADULT  
 200/150(165) ADULT  
 255/195(215) NEONATE  
 60/ 30( 40) NEONATE  
 80/ 50( 62) NEONATE  
 100/ 65( 75) NEONATE  
 120/ 80( 90) NEONATE  
 150/100(115) NEONATE  
 120/ 80( 90) PAC  
 120/ 80( 90) PVC  
 120/ 80( 90) AFIB  
 120/ 80( 90) MBC  
 120/ 80( 90) ASC

Heart Rate: (except for arrhythmias)  
 30 to 240 BPM (80 nominal)

Envelope Gain: (except for arrhythmias)  
 0 to 200 % (100 nominal)

Envelope Shift: (except for arrhythmias)  
 Zero

Positive: 0 to 100

Negative: 0 to 100

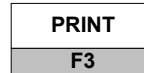
- NIBP +/- LIMIT: 0 to 99 % (0 off, 20 nominal)
- HEART RATE +/- LIMIT: 0 to 99 BPM  
 (0 off, 4 nominal)
- PRESSURE TEST
- LEAK TEST
- POP OFF TEST

After customizing your autosequence, the medTester prompts you to store the autosequence:



### Print Your Autosequence

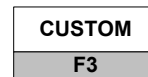
From the NIBP custom autosequences menu described above, printing any autosequence is accomplished through this menu command:



### Reinitialize Factory Default Settings

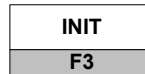
Any customized autosequences can be returned to the factory default settings. To do this, enter these medTester commands:

1. From the medTester 5000C main menu, MENU1, press the right arrow to access MENU2.

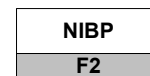


2. Enter the command:

3. From the custom menu, press the right arrow and enter the

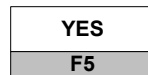


command:



4. Press the right arrow, and then press:

5. To initialize NIBP autosequences to defaults, press:





## A

- AAMI load, 1-13**
- Accessories, 1-17**
- Audio Transducer, 2-4**
- Autosequences**
  - defined, 5-1**
  - monitoring**
    - environmental, 5-17
    - line voltage, 5-16
  - optional monitoring, 5-15**
  - prompts**
    - end of test, 5-11
  - safety**
    - description of, 5-2
    - ECG performance waveforms in, 5-10
    - names of, 5-4
    - printing and storing records, 5-12
    - steps in, 5-7
  - selection methods, 5-3**

## B

- Bar code**
  - entering multiple labels, 6-93

## C

- Checklists**
  - erasing all checklists, 8-6
  - printing, 8-8
- Commands**
  - keyboard shortcuts, 8-9
- Controls**
  - rear panel, 3-3
  - top panel, 3-1
- Customize**
  - blank safety autosequences, 6-87
  - defibrillator autosequences, 9-12
  - ESU autosequences, 14-15
  - fields in summary of stored records, 6-92
  - IV pump autosequences, 10-22
  - leakage current tests in safety autosequences, 6-85
  - menu steps in safety autosequences, 6-83
  - preprogrammed safety autosequences. *See* prompts, autosequence, 6-88
  - prompts, autosequence, 6-88
  - SPO2 autosequences, 15-24

## Index

- test record header, 6-87

## D

- Date and Time Setup, 2-3**
- Defibrillator autosequences**
  - limits, 9-11
  - names and command list, 9-3
  - running, 9-5
  - test sequence, 9-7

## E

- ESU autosequences**
  - described, 14-10
  - names and menu commands, 14-4
  - running, 14-5
  - test sequence, 14-7
  - test types, 14-7

## F

- Features, 1-5**

## G

- Ground Fault Circuit Interrupter, 1-15**

## H

- Help**
  - Where to find, 1-4

## I

- Initialization, 2-3**
- IV pump autosequences**
  - limits, 10-19
  - names and commands, 10-4
  - running, 10-7

## M

- Manual tests**
  - ECG lead leakage, 4-38
  - equipment current, 4-42
  - isolated power and ground fault, 4-44
  - leakage current, 4-36
  - line voltage, 4-35
  - printing measurements, 4-35
  - resistance, 4-42
- medCheck**
  - checklist files, 11-6
  - checklist, items in, 11-9
  - checklists, print and view, 11-12
  - checklists, running, 11-6

- checklists, using, 11-3
- Memory**
  - checking contents of, 8-6
- Menus**
  - navigating, 3-4
- Modules, list of, 1-8**
- modules, optional**
  - overview, 1-2
- Modules, how to find, 1-7**

## P

- Pauses**
  - between displayed measurements, 6-91
- Performance waves**
  - in safety autosequences, 7-5
  - outputting, 7-1
  - running from the *Waves* menu, 7-4
  - waveform groups, 7-2
- Power-Up Sequence, 2-2**
- Printer**
  - configuring lines, pages, 8-5
- prompts**
  - to enter autosequence information, 5-5
- Prompts**
  - renaming, 6-90
  - turning off, 5-6
  - turning on and off, 6-89

## R

- Remote operation**
  - communications settings, 12-2
  - file transfer protocol, 12-9
  - Local Mode**
    - input, 12-3
    - output, 12-4
  - mode, local vs. remote, 12-1
  - port diagnostics, 12-17
  - remote commands, list of, 12-12
  - remote mode, 12-6
  - responses
    - errors, 12-8
    - to commands, 12-7
  - serial ports, 12-1

## S

- serial ports**
  - configuring Wedge ports, 13-2
  - expanding the number of with the Wedge, 13-2

## Settings

- factory default, 2-1
- reinitialize defibrillator autosequences, 9-14, 15-29
- reinitialize ESU autosequences, 14-18
- reinitialize IV pump autosequences, 10-26
- resetting autosequences to defaults, 6-94
- Specifications**
  - general, 1-16
  - instrument, 1-12
- SPO2 autosequences**
  - customizing, 15-24
  - described, 15-15
  - names and command list, 15-4
  - running, 15-8
  - test sequence, 15-11

## T

- Test Receptacle, 1-14**
- Test records**
  - deleting (single records), 8-6
  - erasing (all records), 8-6
  - printing, 8-2
  - searching for, 8-7
  - viewing (from *Memory* menu), 8-2
- test tag printer**
  - described, 5-13
  - setting up, 5-14
- test tag printing**
  - prompt, 5-11
- Test tags**
  - configuring, 6-91
- Toolbox**
  - humidity, 4-46
  - humidity monitor, 5-21
  - tachometer, 4-45
  - temperature, 4-46
  - temperature monitor, 5-19

## W

### Wedge

- configuring**
  - changing the checklist port, 13-11
  - configuring ports, 13-7
  - configuring ports, the normal port, 13-8
  - configuring, autosequence port, 13-9
  - configuring, checklist port, 13-10
  - enabling, 13-7

**installing, 13-4**  
**operating, 13-7**

**setting baud rates, 13-11**  
**setting output ports, 13-13**

